

**BALDOR**



# **AC Servo Motors and Servo Rated Gearheads**

for the automation industry

# AC Servo Motors

Baldor has been leading the way in energy efficient industrial motors since the 1920's. Baldor also has been supplying the industry with adjustable speed controls since 1952, and has been supplying servo and motion control since 1983.

And ever since the beginning in 1983, Baldor has been supplying reliable servo motor solutions to worldwide applications. Baldor has the design team, experience, application support, test facilities, information, and the solution for your application needs.

Baldor goes beyond the industry standard with innovations to provide reliable performance, while exceeding customer expectations. Some examples of Baldor firsts:

- › stocking of servomotors for with immediate delivery - Baldor's commitment to provide you with service;
- › extra high insulated stator design for protection - Baldor's commitment to provide you with a quality product;
- › superior bearings with improved Exxon Polyrex<sup>®</sup>EM polyrex grease to provide 4 times greater life - Baldor's commitment to you to provide a reliable product;
- › premium high temperature 200°C moisture resistance, multi-coated copper wire for ability to cope with large current spikes - Baldor's commitment to provide you with a superior product.

You have choices, whether that means a product from stock, or a specific custom design for your application - Baldor believes in providing you with choices and is always ready to tackle the most challenging application.

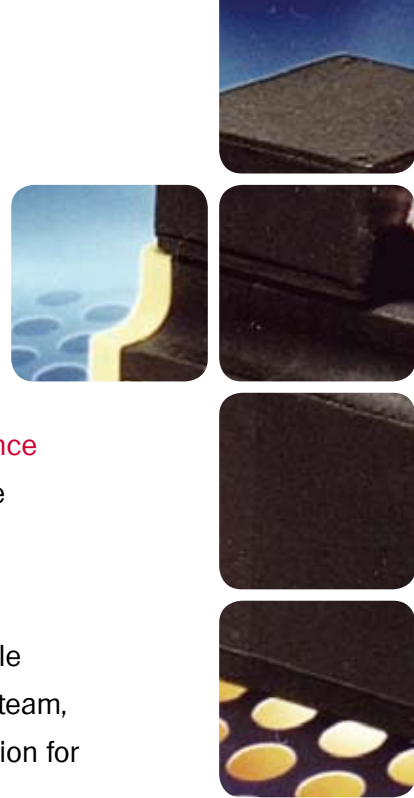

**Page8**  
BSM N-Series  
Low Inertia Brushless Servo Motors



**Page24**  
BSM C-Series  
Standard Inertia Brushless Servo Motors



**Page46**  
SSBSM-Series  
Stainless Steel Servo Motors



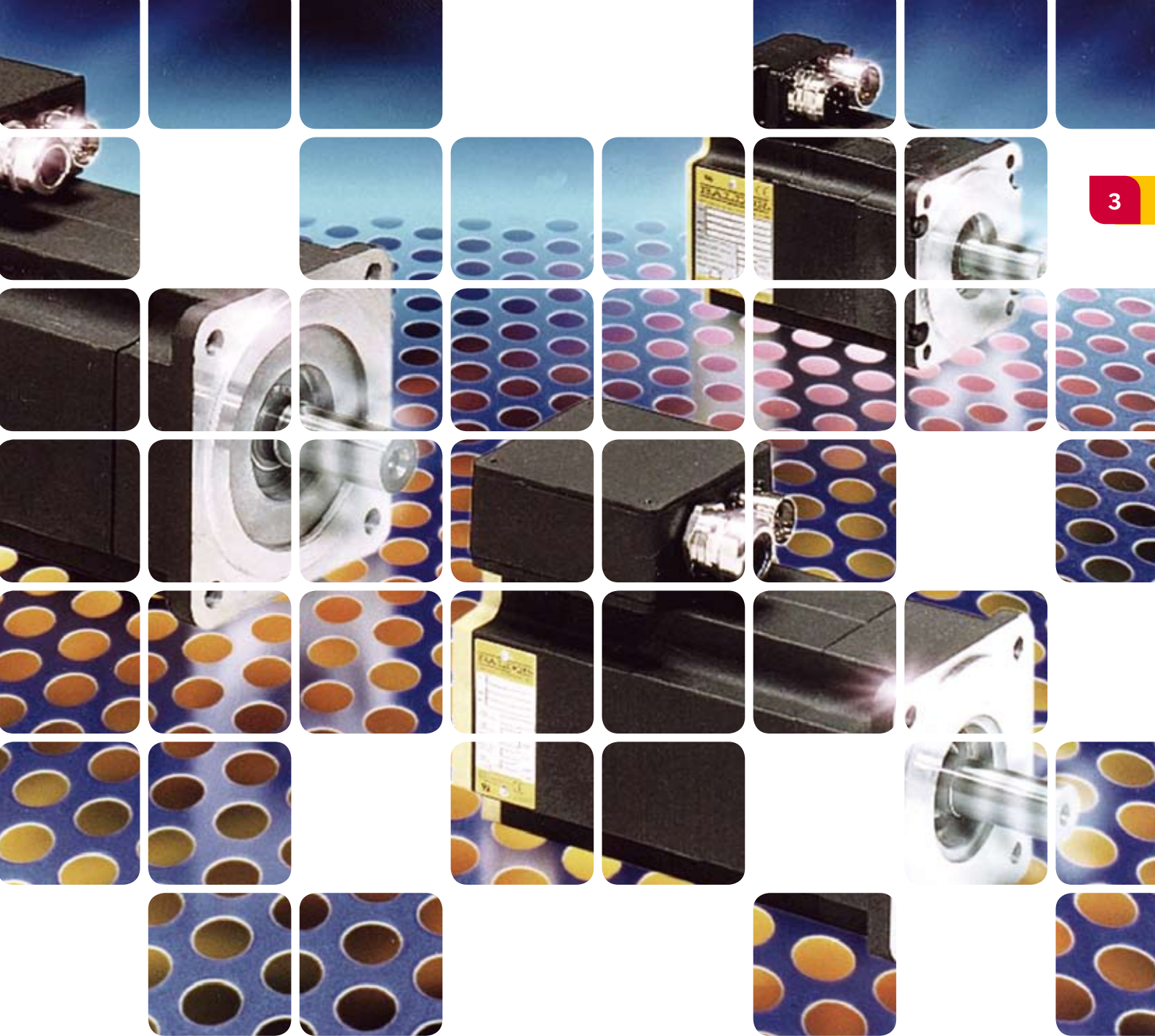

**Page58**  
BSM25/33 Series  
Brushless Motors



**Page65**  
Servo Rated Gearheads  
Low Backlash Planetary Gearheads &  
Stainless Steel Gearheads



**Page89**  
Engineering Information

# Advantages and Solutions from Baldor...

Flexibility and quality...durability and reliability...these have become the keys to application solutions in today's world.

Automation is an investment. Baldor's application experience combined with technical knowledge and experience will aid you in arriving at the right solution. We will help you maximize the return on your investment.

Baldor has a broad spectrum of products available, many from stock...motors, drives, motion controllers...to ensure a high quality, high reliability, low maintenance solution. Baldor's products speed up your machine, while improving product quality and reliability.

Baldor's philosophy is to produce the best products and solutions — Baldor has worldwide engineering and application experience. Experience that delivers the solution. Everything we do, is about meeting or exceeding your expectations.



**1920**  
Baldor begins operation in St. Louis, Missouri



**1952**  
Baldor ships first adjustable speed motor system



**1983**  
Baldor introduces a line of servo motors, controls and programmable motion controllers



**1997**  
Baldor expands the BSM brushless servo motor facility in Westville, Oklahoma



**1997**  
Baldor expands motion control capability with acquisition of Optimised Control, Bristol, England



**1997**  
Baldor introduces linear motors and stages with acquisition of Normag, Santa Clarita, California



**1999**  
Baldor introduces a new family of motion controllers.



**2000**  
Baldor expands their engineering and manufacturing facility in Bristol, England

# Baldor Provides Solutions for your Motion Control requirements...



**2003**

Baldor introduces C-series brushless servos providing up to 50% more torque in smaller packages



**2004**

Baldor expands BSM family with the addition of stainless steel servomotors



**2005**

Baldor adds servo rated, low backlash gear heads to product line



**2006**

Baldor adds stainless steel servo rated gear heads



**2007**

Baldor introduces brushless DC adjustable speed motor and control



**2008**

Baldor introduces linear Honeycomb dual axis motor



**2008**

Baldor introduces servo motors with capability to 20 HP (14Kw), expandable to 34 HP (25Kw) with optional blower

From speed and positioning, to operating the world's fastest machines – Baldor products are hard at work – they increase productivity, improve quality, reduce cost. Baldor products are used in high performance industrial motion control applications such as X-Y tables, cut-to-length, machine tool, robotics, routing, factory automation, moving webs, labeling equipment, pick and place, textile, converting equipment, software clutch, packaging, flying shear and many, many more demanding applications.

Today, that same level of unparalleled quality you get one stop shopping, plus you get to choose from a wide selection of products... Choose from rotary or linear technology, including motors, controls and positioning products. Get instant delivery from stock. Or have a custom product designed to your exact requirements.

User Friendly Features... Motor features which easily fit the design to your application needs – from mounting to electrical windings, from terminations, to feedback devices.

...Control features include quick and easy to use auto-commissioning and auto-tune wizards. These tools make the control a breeze to use.

...Motion controllers which incorporate key functions of motion, I/O handling, communication, networking and operator interface, into a simple easy motion programming package. You get "motion straight out of the box".

Easy Set-up and Operation... And world-wide support... It is this philosophy which has made Baldor the most preferred. For your complete motion control solution, contact Baldor. Baldor is there to support you. You get competent technical assistance in your own neighborhood. This provides you with timely, efficient service with easy access – they are ready to assist you.



# Brushless Servo Motors



Specification	Description
Rating	Continuous duty 155°C rotor temperature - high temperature design for dependability
Wire	Premium 200°C moisture resistant, multi-coated copper wire for improved product reliability
Insulation	UL for 130°C rise rated and potted-provides extra high protection to handle high current spikes
Windings	Variety of electrical windings - application versatility, and design selection
Protection	Internal thermal switch-for proven reliable protection against overheating and overload conditions
Enclosure	Rugged Industrial Construction - quality in the design
Mounting	Standard shaft and mounting - Custom mountings available
Terminations	Standard threaded metric connectors - terminal box on higher power unit - reliable termination
Feedback	Commutation resolver, incremental encoder, absolute encoder, hall sensors
Bearings	Quality grade ball bearings - designed to handle high radial and axial load ratings
Grease	Exxon PolyRex®EM polyurea grease proven to provide four times longer life
Armature	Proven design - provides superior application performance
Brakes	Optional holding brakes available - design choices for the application
UL/CSA/CE/BISSC	Agency approvals - proven designs, proven quality

Baldor's Brushless Servo Motors provide low rotor inertia for high torque to inertia ratio in a very compact package. Designed for durability, high temperature, and ability to handle harsh environments in applications. Wide variety of models available from stock.

**Electrical windings -  
wide selection and wide  
voltage range - even up to  
600 VDC Bus**

**Permanent Magnet Rotor -  
durable, time proven, reliable  
design provides the highest  
torque to inertia ratio for rapid  
positioning capability**

**Stator potted for  
environmental protection,  
current spike protection  
and high voltage protection**

**Bearings with Exxon  
PolyRex® EM polyurea grease  
proven to provide up to four  
times longer life and greater  
shear durability**

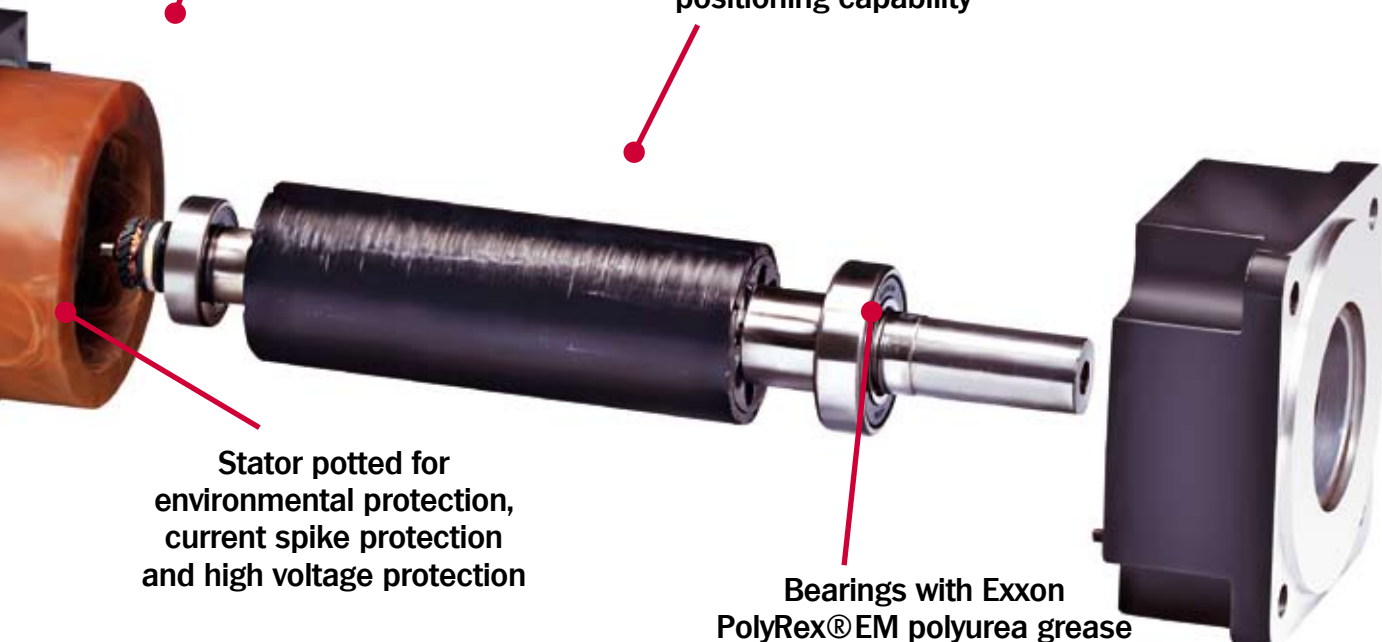

**Typical BSM 90/100 shown  
BSM 50/63/80 Series use connectors.**

# Brushless Servo N-Series

The BSM N Series provides the lowest inertia and high torque desired for excellent performance response. This series is a rugged, durable industrial design and construction with Neodymium Iron Boron magnetics. They are capable of peak torques equal to four times continuous to provide the highest acceleration torques in applications. Baldor BSM motors are available with a wide variety of feedback devices to suit application needs. IEC and NEMA configurations are available.

Motor Family	Size		Torque Range	
	mm	in	lb-in	Nm
BSM50	55	2.1	3.9-12	0.45-1.36
BSM63	67	2.6	6.8-18.5	0.7-2.8
BSM80	89	3.5	14.6-40	1.6-4.5
BSM90	120	4.7	53-117	6-13.3
BSM100	146	5.7	123-354	14-40



BSM N

Variety of feedback options:

- › Resolver
- › Incremental/Absolute Encoders
- › Hall sensors

Popular shaft/mounting dimensions

- › Stock and custom
- › IEC and NEMA

Rugged Construction

- › Sealed to IP60
- › With shaft oil seal sealed to IP65
- › 95% RH Non-Condensing
- › 1000 m (3300 Feet) without derate

Proven reliable bearings. 4 times longer bearing life.

Optional shaft seal.

Captured front bearing eliminates axial movement

Precision wrapped rotor. High acceleration capability - to move faster, to get the job done faster. High torque to inertia ratio - enables your machine to produce more parts per hour.

Moisture/Dust resistant o-rings. Environmentally rugged - for reliability and long life.

High temperature operation. Over temperature protection thermal switch. Heavy duty continuous operation - for dependable performance.

High voltage insulation. Windings potted for additional voltage protection - for improved reliability and improved heat transfer.

Cooling kits available on some models - to obtain more performance and extend torque range.

Optional holding brakes available.

Typical BSM63/80 series shown





## BSM N-Series

The BSM N-Series provides applications with low inertia to attain the highest acceleration capability - to position faster - to obtain the highest machine throughput. Baldor's motors are hard at work, increasing productivity, improving part quality, providing precision and reducing cost in many applications. This series provides continuous stall torques ranging from 3.9 lb-in (0.4 N-m) to 354 lb-in (40 N-m). Peak torques are four times continuous. This series has the lowest inertia to provide the maximum torque per package size.

## AC Servo Motors - N-Series

Continuous Stall Torque		Continuous Stall Amps	Speed RPM @ 320V ①	Motor Number ②	Motor Inertia	
Lb-In	Nm				Lb-In-S <sup>2</sup>	Kg - cm <sup>2</sup>
3.9	0.45	1.49 0.79	7500 4000	BSM50N-133AX BSM50N-175AX	0.00006	0.0677
6.8	0.77	2.0 1.8 1.0	9000 6000 4000	BSM63N-133AX BSM63N-150AX BSM63N-175AX	0.00018	0.2031
7.9	0.9	2.8 1.4	7500 3750	BSM50N-233AX BSM50N-275AX	0.00011	0.125
12	1.36	4.5 2.3	7500 4000	BSM50N-333AX BSM50N-375AX	0.00016	0.180
13	1.47	3.9 2.8 1.9	9000 6000 4000	BSM63N-233AX BSM63N-250AX BSM63N-275AX	0.00034	0.384
14.6	1.65	4.7 3.0 2.1	9000 6000 4000	BSM80N-133AX BSM80N-150AX BSM80N-175AX	0.00091	1.02
18.5	2.0	6.0 4.0 2.8	9000 6000 4000	BSM63N-333AX BSM63N-350AX BSM63N-375AX	0.0005	0.564
28.3	3.2	8.7 5.6 3.9	9000 6000 4000	BSM80N-233AX BSM80N-250AX BSM80N-275AX	0.00162	1.82
38	4.3	12.9 8.6 5.5	9000 6000 4000	BSM80N-333AX BSM80N-350AX BSM80N-375AX	0.00223	2.519
53	6	7.8 4.0 2.6	4000 2000 1200	BSM90N-175AX BSM90N-1150AX BSM90N-1250AX	0.0030	3.389
88	10	11.6 6.1 4.1	4000 2000 1200	BSM90N-275AX BSM90N-2150AX BSM90N-2250AX	0.0056	6.327
117	13.3	1.9 8.6 5.5	4000 2000 1200	BSM90N-375AX BSM90N-3150AX BSM90N-3250AX	0.0082	9.264
123	14	9.4 5.9	2000 1200	BSM100N-1150AX BSM100N-1250AX	0.0120	13.558
203	23	15.5 9.9	2000 1200	BSM100N-2150AX BSM100N-2250AX	0.0196	22.145
300	34	21.0 14.7	2000 1200	BSM100N-3150AX BSM100N-3250AX	0.0273	30.844
354	40	26.9 16.8	2000 1200	BSM100N-4150AX BSM100N-4250AX	0.0349	39.431

NOTE: ① Nominal rpm shown at 320 VDC bus for convenience. For 640 VDC double the speed. Reference motor table to verify that max speed is not exceeded. ② For X callout, see motor ID matrix under engineering information.

# BSM N-Series Performance Curves

10

## BSM50N-133

## BSM50N-175

## BSM50N-233

BSM N

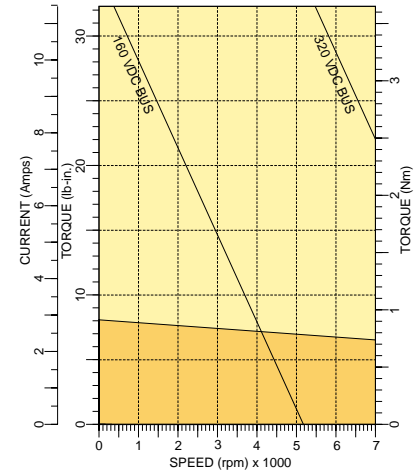
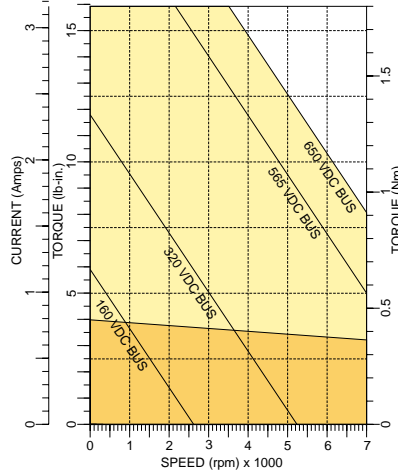
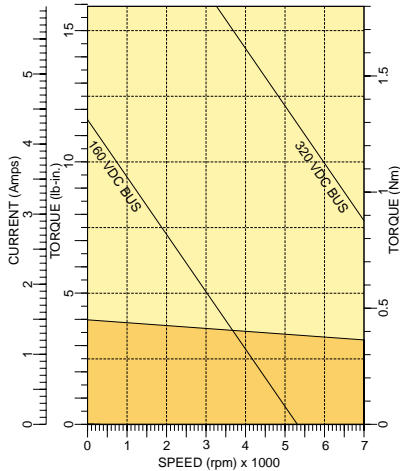

Model Number		BSM50N-133	BSM50N-175	BSM50N-233
<b>General</b>				
Continuous Stall Torque	lb-in	3.9	3.9	7.9
	N-m	0.45	0.45	0.9
Continuous Stall Current	amps	1.49	0.79	2.87
Peak Torque	lb-in	15.9	15.9	32.3
	N-m	1.80	1.80	3.65
Peak Current	amps	5	2.52	9.91
Thermal Resistance	°C/watt	3.0	3.0	2.6
Thermal Time Constant	Min	7	7	11
Mechanical Time Constant	msec	0.6	0.6	0.38
Electrical Time Constant	msec	1.3	1.3	2.1
Rated Speed @300 volts	rpm	7500	4000	7500
Rated Speed @160 volts	rpm	4000	1000	4000
<b>Electrical</b>				
Torque Constant	lb-in/amp	3.14	6.31	3.25
	N-m/amp	0.35	0.71	0.36
Voltage Constant	Vpk/krpm	30.37	60.94	32
	Vrms/krpm	21.48	43.1	22.7
Resistance	ohms	11.95	47.5	4.0
Inductance	mH	16.5	63.5	8.3
<b>Mechanical</b>				
Inertia	lb-in-s <sup>2</sup>	0.00006	0.00006	0.00011
	Kg-cm <sup>2</sup>	0.0677	0.0677	0.124
Maximum Speed	rpm	10,000	10,000	10,000
Number of Motor Poles		4	4	4
Weight	lbs/Kg	2.4/1.1	2.4/1.1	3.4/1.6

# BSM N-Series Performance Curves

## BSM50N-275

## BSM50N-333

## BSM50N-375

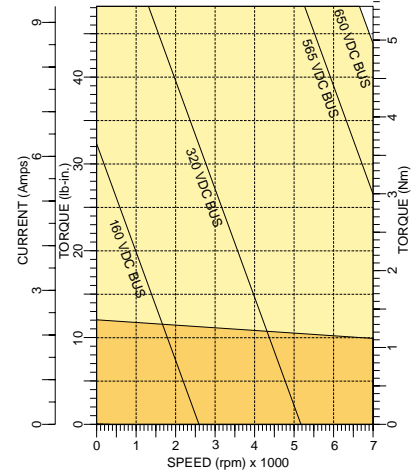
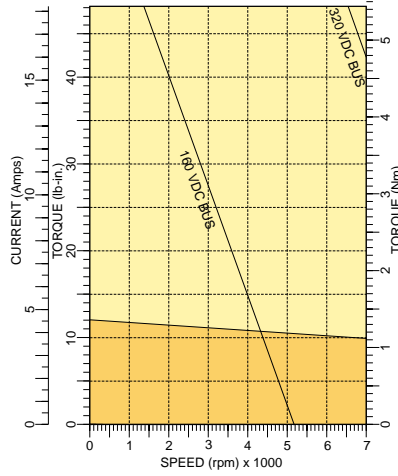
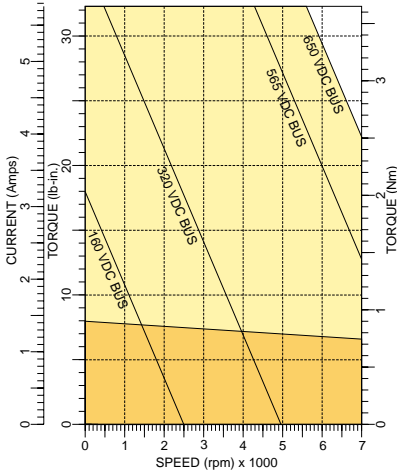

Model Number		BSM50N-275	BSM50N-333	BSM50N-375
<b>General</b>				
Continuous Stall Torque	lb-in	7.9	12	12
	N-m	0.9	1.36	1.36
Continuous Current	amps	1.42	4.56	2.38
Peak Torque	lb-in	32	48.15	48.15
	N-m	3.65	5.44	5.44
Peak Current	amps	4.87	15	8
Thermal Resistance	°C/watt	2.6	1.8	1.8
Thermal Time Constant	Min	11	15	15
Mechanical Time Constant	msec	0.35	0.29	0.30
Electrical Time Constant	msec	2.1	1.9	1.8
Rated Speed @300 volts	rpm	4000	7500	4000
Rated Speed @160 volts	rpm	2000	4000	1500
<b>Electrical</b>				
Torque Constant	lb-in/amp	6.66	3.2	6.4
	N-m/amp	0.75	0.36	0.72
Voltage Constant	Vpk/krpm	64.3	30.9	61.9
	Vrms/krpm	45.5	21.89	43.8
Resistance	ohms	16	2.1	8.5
Inductance	mH	33.2	4.1	16
<b>Mechanical</b>				
Inertia	lb-in-s <sup>2</sup>	0.00011	0.00016	0.00016
	Kg-cm <sup>2</sup>	0.124	0.18	0.18
Maximum Speed	rpm	10,000	10,000	10,000
Number of Motor Poles		4	4	4
Weight	lbs/Kg	3.4/1.6	4.4/2	4.4/2

# BSM N-Series Performance Curves

12

**BSM63N-133**

**BSM63N-150**

**BSM63N-175**

BSM N

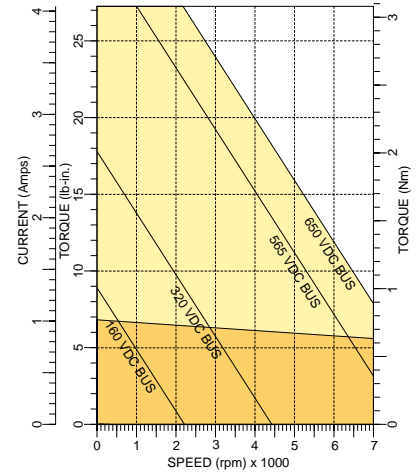
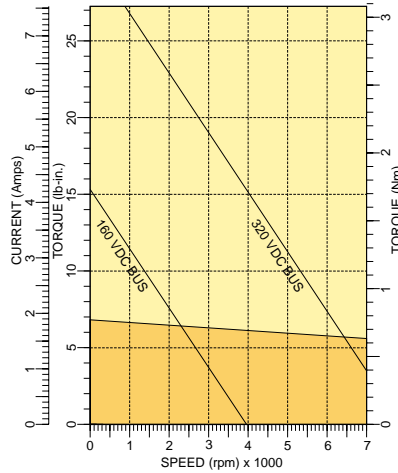
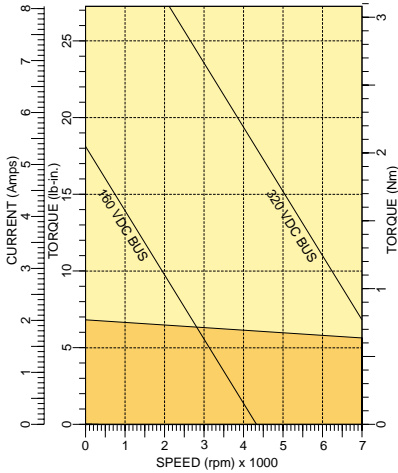

Model Number		BSM63N-133	BSM63N-150	BSM63N-175
<b>General</b>				
Continuous Stall Torque	lb-in	6.8	6.8	6.8
	N-m	0.77	0.77	0.77
Continuous Current	amps	2.01	1.83	1.01
Peak Torque	lb-in	27.25	27.25	27.25
	N-m	3.08	3.08	3.08
Peak Current	amps	7.24	6.59	3.64
Thermal Resistance	°C/watt	2.2	2.2	2.2
Thermal Time Constant	Min	13	13	13
Mechanical Time Constant	msec	1.0	1.1	1.0
Electrical Time Constant	msec	1.5	2	2.1
Rated Speed @300 volts	rpm	9000	6000	4000
Rated Speed @160 volts	rpm	4000	3200	2130
<b>Electrical</b>				
Torque Constant	lb-in/amp	3.75	4.12	7.46
	N-m/amp	0.425	0.467	0.844
Voltage Constant	Vpk/krpm	36.3	39.9	72.1
	Vrms/krpm	25.7	28.2	51.0
Resistance	ohms	9.4	12.1	37.4
Inductance	mH	12.77	17.20	53.63
<b>Mechanical</b>				
Inertia	lb-in-s <sup>2</sup>	0.00018	0.00018	0.00018
	Kg-cm <sup>2</sup>	0.2031	0.2031	0.2031
Maximum Speed	rpm	10,000	10,000	10,000
Number of Motor Poles		4	4	4
Weight	lbs/Kg	3.7/1.68	3.7/1.68	3.7/1.68



# BSM N-Series Performance Curves

**BSM63N-233**

**BSM63N-250**

**BSM63N-275**

13

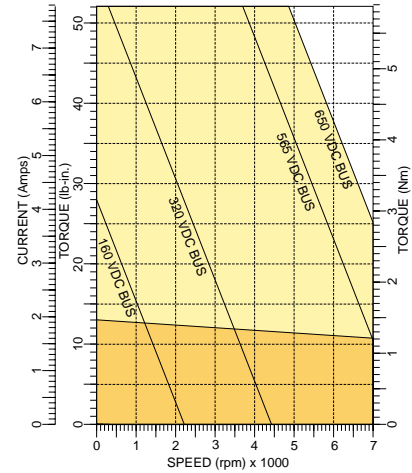
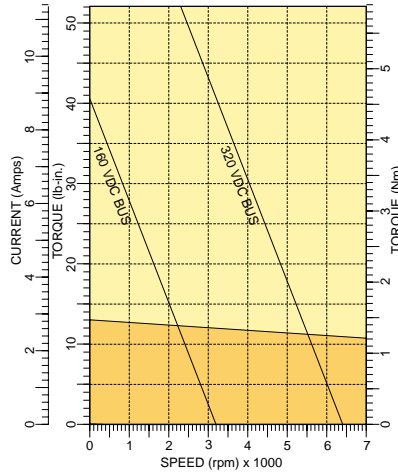
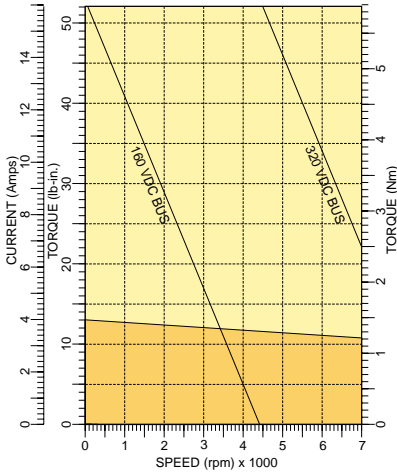

BSM N

Model Number		BSM63N-233	BSM63N-250	BSM63N-275
<b>General</b>				
Continuous Stall Torque	lb-in	13	13	13
	N-m	1.47	1.47	1.47
Continuous Current	amps	3.93	2.82	1.94
Peak Torque	lb-in	52.04	52.04	52.04
	N-m	5.88	5.88	5.88
Peak Current	amps	14.1	10.1	6.96
Thermal Resistance	°C/watt	1.9	1.9	1.9
Thermal Time Constant	Min	19	19	19
Mechanical Time Constant	msec	0.69	0.64	0.62
Electrical Time Constant	msec	1.5	2.0	2.1
Rated Speed @300 volts	rpm	9000	6000	4000
Rated Speed @160 volts	rpm	4800	3200	2130
<b>Electrical</b>				
Torque Constant	lb-in/amp	3.67	5.12	7.47
	N-m/amp	0.415	0.579	0.844
Voltage Constant	Vpk/krpm	35.4	49.4	72.1
	Vrms/krpm	25.0	34.9	51.0
Resistance	ohms	3.1	5.6	11.6
Inductance	mH	4.75	11.57	24.77
<b>Mechanical</b>				
Inertia	lb-in-s <sup>2</sup>	0.00034	0.00034	0.00034
	Kg-cm <sup>2</sup>	0.384	0.384	0.384
Maximum Speed	rpm	10,000	10,000	10,000
Number of Motor Poles		4	4	4
Weight	lbs/Kg	5/2.3	5/2.3	5/2.3

# BSM N-Series Performance Curves

14

## BSM63N-333

## BSM63N-350

## BSM63N-375

BSM N

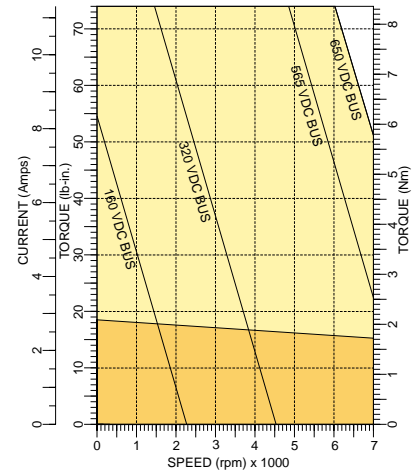
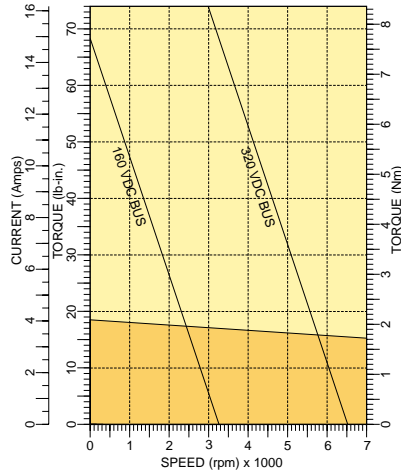
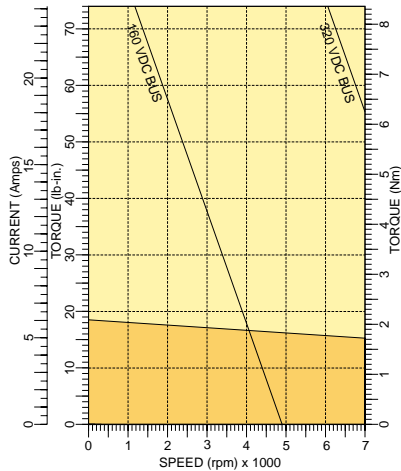

Model Number		BSM63N-333	BSM63N-350	BSM63N-375
<b>General</b>				
Continuous Stall Torque	lb-in	18.5	18.5	18.5
	N-m	2.09	2.09	2.09
Continuous Current	amps	6.03	4.05	2.82
Peak Torque	lb-in	73.99	73.99	73.99
	N-m	8.36	8.36	8.36
Peak Current	amps	21.7	14.5	10.1
Thermal Resistance	°C/watt	1.6	1.6	1.6
Thermal Time Constant	Min	25	25	25
Mechanical Time Constant	msec	0.57	0.57	0.50
Electrical Time Constant	msec	1.9	1.79	2.3
Rated Speed @300 volts	rpm	9000	6000	4000
Rated Speed @160 volts	rpm	4800	3200	2130

<b>Electrical</b>				
Torque Constant	lb-in/amp	3.41	5.07	7.28
	N-m/amp	0.385	0.573	0.823
Voltage Constant	Vpk/krpm	32.8	49.0	70.2
	Vrms/krpm	23.25	34.6	49.7
Resistance	ohms	1.5	3.28	5.92
Inductance	mH	2.85	5.87	13.67

<b>Mechanical</b>				
Inertia	lb-in-s <sup>2</sup>	0.00050	0.00050	0.00050
	Kg-cm <sup>2</sup>	0.564	0.564	0.564
Maximum Speed	rpm	10,000	10,000	10,000
Number of Motor Poles		4	4	4
Weight	lbs/Kg	6.3/2.9	6.3/2.9	6.3/2.9

# BSM N-Series Performance Curves

**BSM80N-133**

**BSM80N-150**

**BSM80N-175**

15

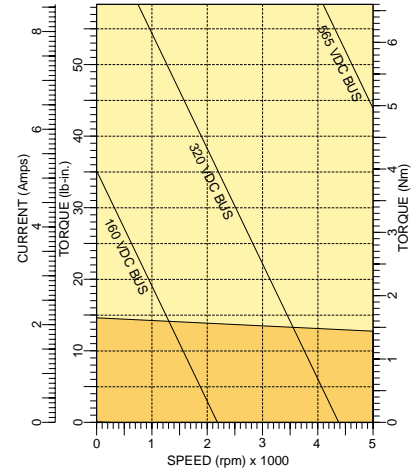
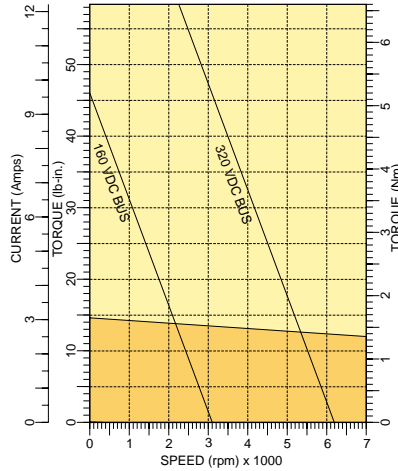
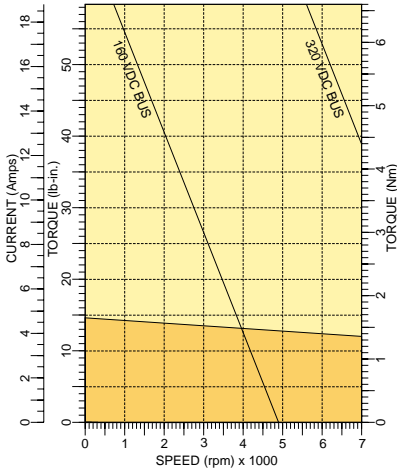

BSM N

Model Number		BSM80N-133	BSM80N-150	BSM80N-175
<b>General</b>				
Continuous Stall Torque	lb-in	14.6	14.6	14.6
	N-m	1.65	1.65	1.65
Continuous Current	amps	4.74	3.05	2.14
Peak Torque	lb-in	58.41	58.41	58.41
	N-m	6.6	6.6	6.6
Peak Current	amps	17.1	11.0	7.69
Thermal Resistance	°C/watt	1.84	1.84	1.84
Thermal Time Constant	Min	23	23	23
Mechanical Time Constant	msec	1.5	1.4	1.3
Electrical Time Constant	msec	2.4	2.7	2.9
Rated Speed @300 volts	rpm	--	6000	4000
Rated Speed @160 volts	rpm	4800	3200	2130
<b>Electrical</b>				
Torque Constant	lb-in/amp	3.4	5.3	7.5
	N-m/amp	0.386	0.6	0.85
Voltage Constant	Vpk/krpm	33	51.3	73.3
	Vrms/krpm	23.3	36.3	51.8
Resistance	ohms	2.1	5.1	9.53
Inductance	mH	5.2	13.97	28.0
<b>Mechanical</b>				
Inertia	lb-in-s <sup>2</sup>	0.00091	0.00091	0.00091
	Kg-cm <sup>2</sup>	1.02	1.02	1.02
Maximum Speed	rpm	7000	7000	7000
Number of Motor Poles		4	4	4
Weight	lbs/Kg	7/3.2	7/3.2	7/3.2

# BSM N-Series Performance Curves

16

**BSM80N-233**

**BSM80N-250**

**BSM80N-275**

BSM N

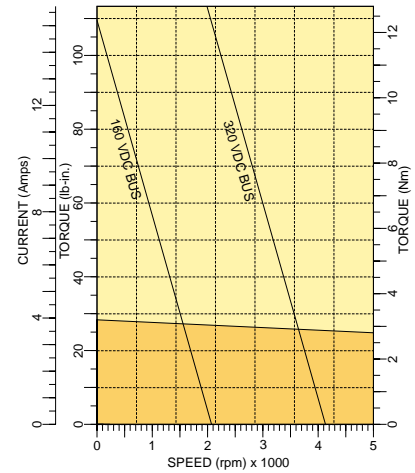
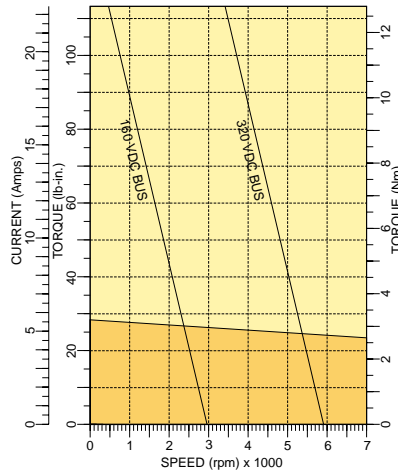
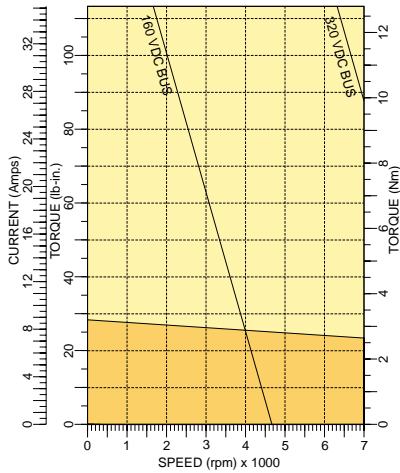

Model Number		BSM80N-233	BSM80N-250	BSM80N-275
<b>General</b>				
Continuous Stall Torque	lb-in	28.3	28.3	28.3
	N-m	3.2	3.2	3.2
Continuous Current	amps	8.76	5.61	3.93
Peak Torque	lb-in	113.28	113.28	113.28
	N-m	12.8	12.8	12.8
Peak Current	amps	31.5	20.2	14
Thermal Resistance	°C/watt	1.5	1.5	1.5
Thermal Time Constant	Min	28	28	28
Mechanical Time Constant	msec	0.95	0.84	0.72
Electrical Time Constant	msec	3.2	2.9	3.9
Rated Speed @300 volts	rpm	--	6000	4000
Rated Speed @160 volts	rpm	4800	3200	2130
<b>Electrical</b>				
Torque Constant	lb-in/amp	3.59	5.6	8.0
	N-m/amp	0.406	0.633	0.904
Voltage Constant	Vpk/krpm	34.7	54.1	77.3
	Vrms/krpm	24.6	38.29	54.7
Resistance	ohms	0.832	1.81	3.2
Inductance	mH	2.73	5.30	12.73
<b>Mechanical</b>				
Inertia	lb-in-s <sup>2</sup>	0.00162	0.00162	0.00162
	Kg-cm <sup>2</sup>	1.82	1.82	1.82
Maximum Speed	rpm	7000	7000	7000
Number of Motor Poles		4	4	4
Weight	lbs/Kg	10/4.6	10/4.6	10/4.6



# BSM N-Series Performance Curves

**BSM80N-333**

**BSM80N-350**

**BSM80N-375**

17

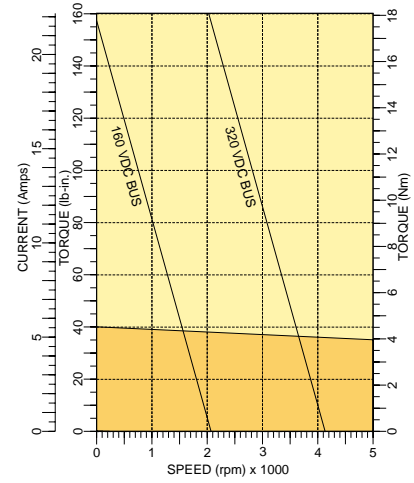
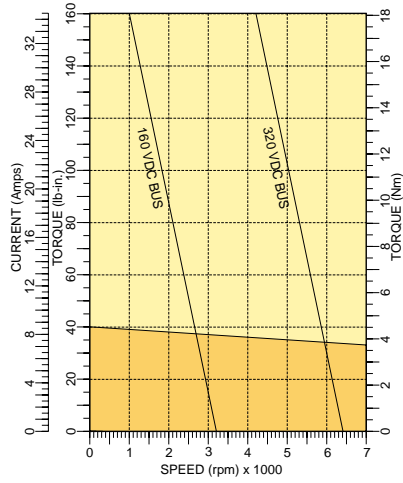
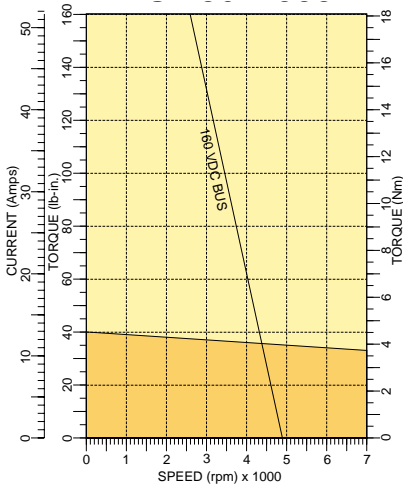

BSM N

Model Number		BSM80N-333	BSM80N-350	BSM80N-375
<b>General</b>				
Continuous Stall Torque	lb-in	40	40	40
	N-m	4.52	4.52	4.52
Continuous Current	amps	12.98	8.61	5.54
Peak Torque	lb-in	160	160	160
	N-m	18.08	18.08	18.08
Peak Current	amps	46.71	31.01	19.96
Thermal Resistance	°C/watt	1.22	1.22	1.22
Thermal Time Constant	Min	34	34	34
Mechanical Time Constant	msec	0.75	0.70	0.69
Electrical Time Constant	msec	3.9	4.3	4.2
Rated Speed @300 volts	rpm	--	6000	4000
Rated Speed @160 volts	rpm	4800	3200	2130
<b>Electrical</b>				
Torque Constant	lb-in/amp	3.42	5.15	8.01
	N-m/amp	0.387	0.583	0.906
Voltage Constant	Vpk/krpm	33.2	49.7	77.4
	Vrms/krpm	23.41	35.2	54.7
Resistance	ohms	0.433	0.935	2.22
Inductance	mH	1.70	4.00	9.30
<b>Mechanical</b>				
Inertia	lb-in-s <sup>2</sup>	0.00223	0.00223	0.00223
	Kg-cm <sup>2</sup>	2.519	2.519	2.519
Maximum Speed	rpm	7000	7000	7000
Number of Motor Poles		4	4	4
Weight	lbs/Kg	13/6	13/6	13/6

# BSM N-Series Performance Curves

18

## BSM90N-175

## BSM90N-1150

## BSM90N-1250

BSM N

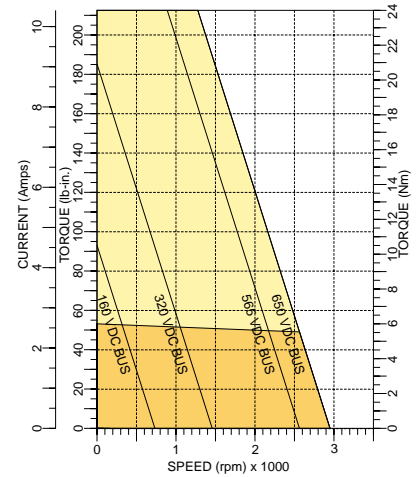
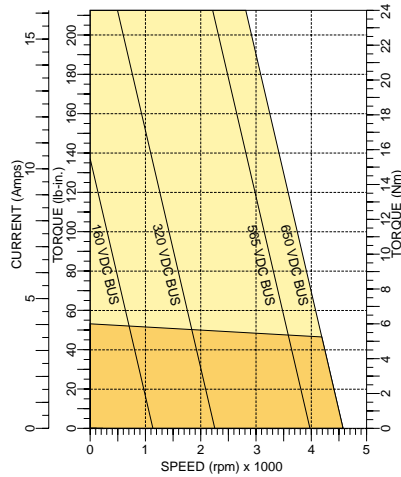
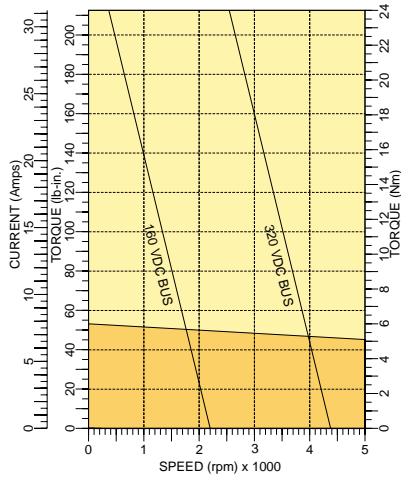

Model Number		BSM90N-175	BSM90N-1150	BSM90N-1250
<b>General</b>				
Continuous Stall Torque	lb-in	53	53	53
	N-m	6	6	6
Continuous Current	amps	7.8	4.03	2.6
Peak Torque	lb-in	212.41	212.41	212.41
	N-m	24	24	24
Peak Current	amps	28.1	14.5	9.37
Thermal Resistance	°C/watt	1.16	1.16	1.16
Thermal Time Constant	Min	38	38	38
Mechanical Time Constant	msec	0.58	0.54	0.55
Electrical Time Constant	msec	3.3	4.0	4.1
Rated Speed @300 volts	rpm	4000	2000	1200
Rated Speed @600 volts	rpm	--	4000	2400
<b>Electrical</b>				
Torque Constant	lb-in/amp	7.31	14.16	21.93
	N-m/amp	0.853	1.65	2.56
Voltage Constant	Vpk/krpm	72.8	141.3	218.9
	Vrms/krpm	51.5	99.9	154.8
Resistance	ohms	1.24	4.33	10.66
Inductance	mH	4.15	17.6	43.50
<b>Mechanical</b>				
Inertia	lb-in-s <sup>2</sup>	0.0030	0.0030	0.0030
	Kg-cm <sup>2</sup>	3.389	3.389	3.389
Maximum Speed	rpm	7000	7000	7000
Number of Motor Poles		8	8	8
Weight	lbs/Kg	18/8.2	18/8.2	18/8.2

# BSM N-Series Performance Curves

**BSM90N-275**

**BSM90N-2150**

**BSM90N-2250**

19

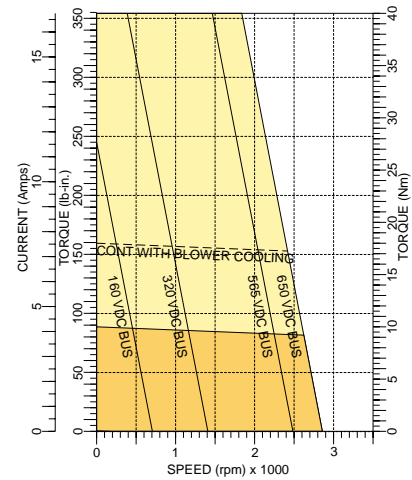
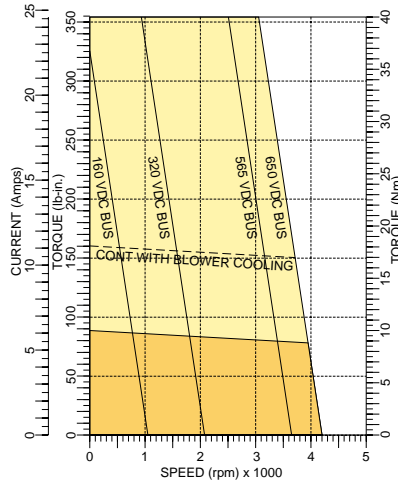
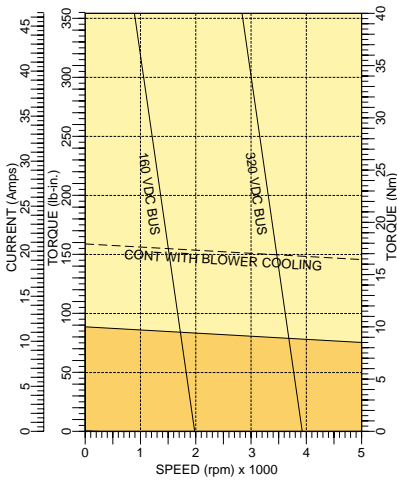

BSM N

Model Number		BSM90N-275 ①	BSM90N-2150 ①	BSM90N-2250 ①
<b>General</b>				
Continuous Stall Torque	lb-in	88	88	88
	N-m	10	10	10
Continuous Current	amps	11.6	6.15	4.19
Peak Torque	lb-in	354	354	354
	N-m	40	40	40
Peak Current	amps	41.8	22.1	15.0
Thermal Resistance	°C/watt	1.15	1.15	1.15
Thermal Time Constant	Min	49	49	49
Mechanical Time Constant	msec	0.36	0.38	0.36
Electrical Time Constant	msec	5.1	5.4	5.7
Rated Speed @300 volts	rpm	4000	2000	1200
Rated Speed @600 volts	rpm	--	4000	2400
<b>Electrical</b>				
Torque Constant	lb-in/amp	8.43	15.9	23.4
	N-m/amp	0.954	1.80	2.65
Voltage Constant	Vpk/krpm	81.5	154.5	226.7
	Vrms/krpm	57.6	109.3	160.3
Resistance	ohms	0.523	1.97	3.94
Inductance	mH	2.66	10.5	22.5
<b>Mechanical</b>				
Inertia	lb-in-s <sup>2</sup>	0.0056	0.0056	0.0056
	Kg-cm <sup>2</sup>	6.327	6.327	6.327
Maximum Speed	rpm	7000	7000	7000
Number of Motor Poles		8	8	8
Weight	lbs/Kg	28/12.7	28/12.7	28/12.7

① A blower cooling option is available which will increase the motor's continuous stall torque by another 80%.

# BSM N-Series Performance Curves

20

## BSM90N-375

## BSM90N-3150

## BSM90N-3250

BSM N

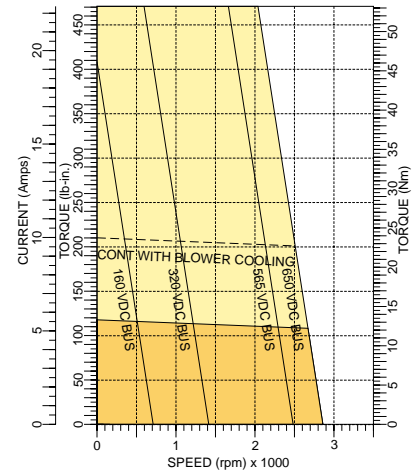
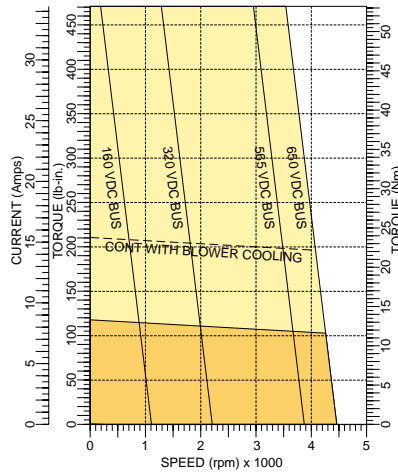
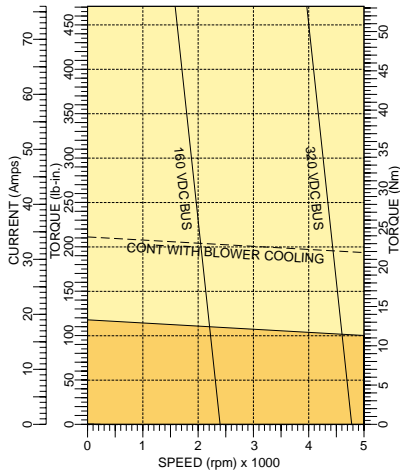

Model Number		BSM90N-375 ①	BSM90N-3150 ①	BSM90N-3250 ①
<b>General</b>				
Continuous Stall Torque	lb-in	117	117	117
	N-m	13.3	13.3	13.3
Continuous Current	amps	19.01	8.64	5.59
Peak Torque	lb-in	471	471	471
	N-m	53.2	53.2	53.2
Peak Current	amps	68.47	31.1	21.1
Thermal Resistance	°C/watt	1.14	1.14	1.14
Thermal Time Constant	Min	59	59	59
Mechanical Time Constant	msec	0.32	0.33	0.32
Electrical Time Constant	msec	2.8	5.4	5.5
Rated Speed @300 volts	rpm	4000	2000	1200
Rated Speed @600 volts	rpm	--	4000	2400
<b>Electrical</b>				
Torque Constant	lb-in/amp	6.8	15.07	23.4
	N-m/amp	0.77	1.7	2.64
Voltage Constant	Vpk/krpm	65.7	145.6	226.3
	Vrms/krpm	46.5	103	160.1
Resistance	ohms	0.2075	1.02	2.39
Inductance	mH	1.257	5.53	13.18
<b>Mechanical</b>				
Inertia	lb-in-s <sup>2</sup>	0.0082	0.0082	0.0082
	Kg-cm <sup>2</sup>	9.264	9.264	9.264
Maximum Speed	rpm	7000	7000	7000
Number of Motor Poles		8	8	8
Weight	lbs/Kg	38/17.3	38/17.3	38/17.3

① A blower cooling option is available which will increase the motor's continuous stall torque by another 80%.



# BSM N-Series Performance Curves

## BSM100N-1150

## BSM100N-1250

## BSM100N-2150

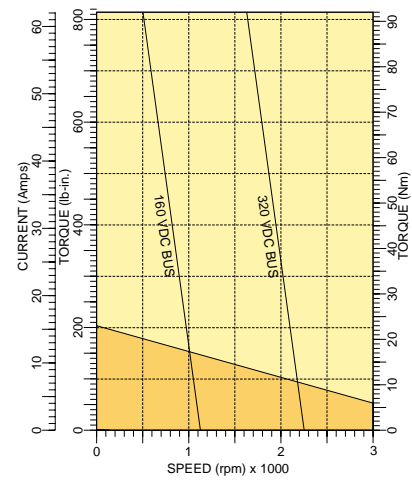
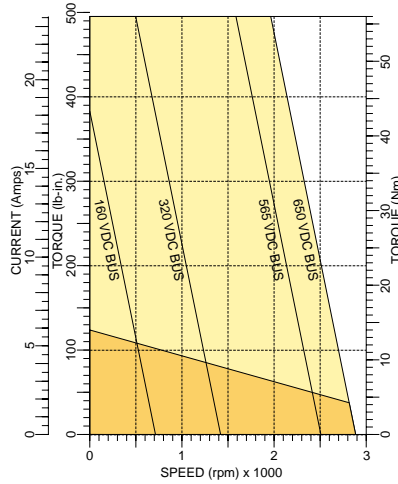
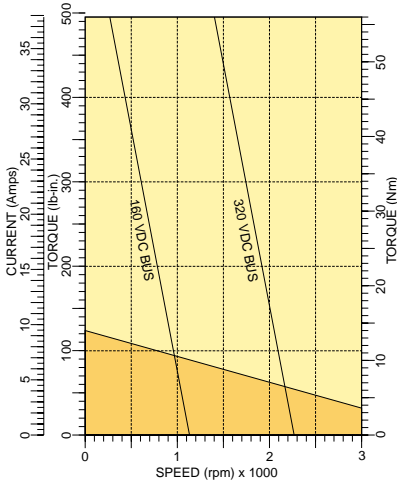

Model Number		BSM100N-1150	BSM100N-1250	BSM100N-2150
<b>General</b>				
Continuous Stall Torque	lb-in	123.9	123.9	203.5
	N-m	14.0	14.0	23.0
Continuous Current	amps	9.4	5.9	15.5
Peak Torque	lb-in	495.6	465.6	814.2
	N-m	56.0	56.0	92
Peak Current	amps	34.0	21.2	55.8
Thermal Resistance	°C/watt	1.05	1.05	1.0
Thermal Time Constant	Min	58	58	67
Mechanical Time Constant	msec	0.47	0.46	0.33
Electrical Time Constant	msec	7.2	7.4	8.3
Rated Speed @300 volts	rpm	2000	1200	2000
Rated Speed @600 volts	rpm	4000	2400	4000
<b>Electrical</b>				
Torque Constant	lb-in/amp	14.5	23.3	14.5
	N-m/amp	1.64	2.6	1.64
Voltage Constant	Vpk/krpm	140.4	225.3	140.8
	Vrms/krpm	99.3	159.4	99.6
Resistance	ohms	0.91	2.25	0.40
Inductance	mH	6.6	17.5	3.3
<b>Mechanical</b>				
Inertia	lb-in-s <sup>2</sup>	0.0120	0.0120	0.0196
	Kg-cm <sup>2</sup>	13.558	13.558	22.145
Maximum Speed	rpm	4000	4000	4000
Number of Motor Poles		8	8	8
Weight	lbs/Kg	35/16	35/16	49/22.3

# BSM N-Series Performance Curves

22

**BSM100N-2250**

**BSM100N-3150**

**BSM100N-3250**

BSM N

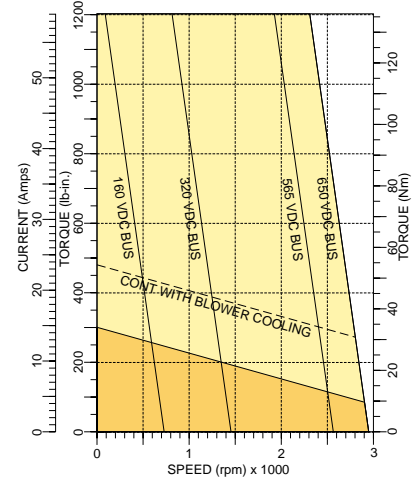
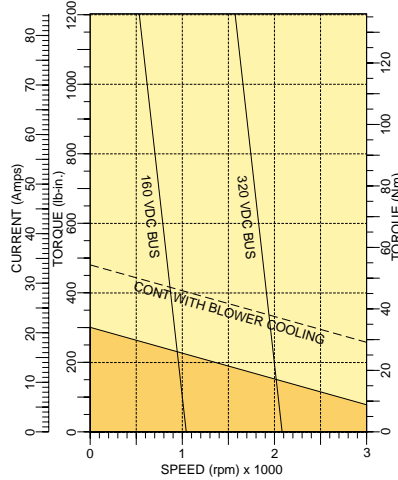
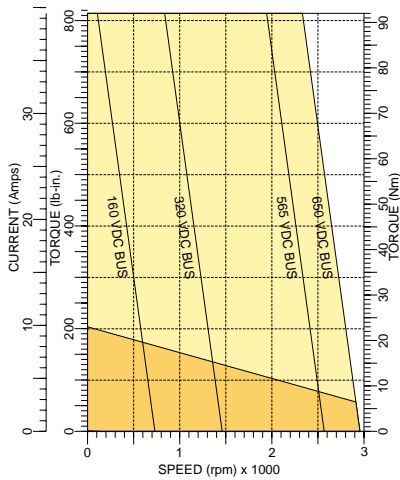

Model Number		BSM100N-2250	BSM100N-3150 ①	BSM100N-3250 ①
<b>General</b>				
Continuous Stall Torque	lb-in	203.5	300	300
	N-m	23.0	34.0	34.0
Continuous Current	amps	9.9	21.0	14.7
Peak Torque	lb-in	814.2	1203.16	1203.6
	N-m	92	136.0	136.0
Peak Current	amps	35.8	75.8	53.1
Thermal Resistance	°C/watt	1.0	0.7	0.7
Thermal Time Constant	Min	67	76	76
Mechanical Time Constant	msec	0.3	0.24	0.29
Electrical Time Constant	msec	9.4	10.9	9.7
Rated Speed @300 volts	rpm	1200	2000	1200
Rated Speed @600 volts	rpm	2400	4000	2400
<b>Electrical</b>				
Torque Constant	lb-in/amp	22.6	15.8	22.6
	N-m/amp	2.56	1.79	2.56
Voltage Constant	Vpk/krpm	219	153.1	218.8
	Vrms/krpm	154.9	108.3	154.7
Resistance	ohms	0.87	0.25	0.61
Inductance	mH	8.25	2.7	5.8
<b>Mechanical</b>				
Inertia	lb-in-s <sup>2</sup>	0.0196	0.0273	0.0273
	Kg-cm <sup>2</sup>	22.145	30.844	30.844
Maximum Speed	rpm	4000	4000	4000
Number of Motor Poles		8	8	8
Weight	lbs/Kg	49/22.3	63/28.6	63/28.6

① A blower cooling option is available which will increase the motor's continuous stall torque by another 60%.

# BSM N-Series Performance Curves

**BSM100N-4150**

**BSM100N-4250**

23

BSM N

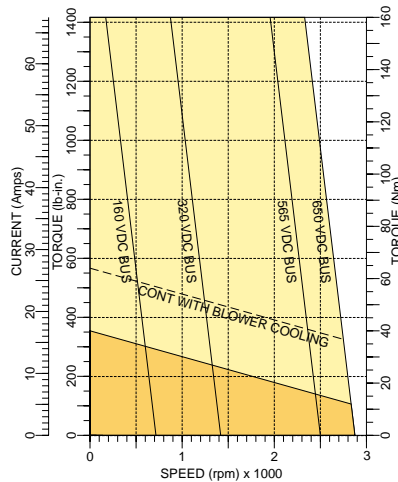
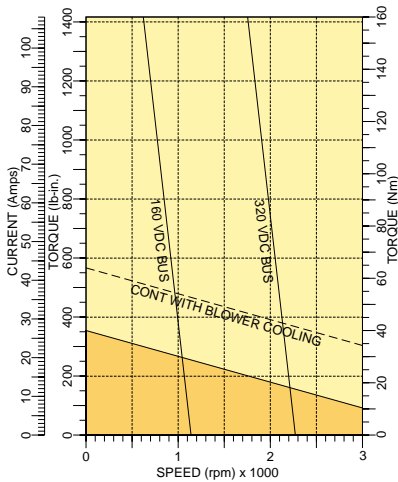

Model Number		BSM100N-4150 ①	BSM100N-4250 ①
<b>General</b>			
Continuous Stall Torque	lb-in	354	354
	N-m	40.0	40
Continuous Current	amps	26.9	16.8
Peak Torque	lb-in	1416.0	1416.0
	N-m	160.0	160.0
Peak Current	amps	97.1	60.7
Thermal Resistance	°C/watt	0.66	0.66
Thermal Time Constant	Min	85	85
Mechanical Time Constant	msec	0.26	0.26
Electrical Time Constant	msec	10.3	10.5
Rated Speed @300 volts	rpm	2000	1200
Rated Speed @600 volts	rpm	4000	2400
<b>Electrical</b>			
Torque Constant	lb-in/amp	14.5	23.2
	N-m/amp	1.64	2.63
Voltage Constant	Vpk/krpm	140.7	225.1
	Vrms/krpm	99.5	159.2
Resistance	ohms	0.18	0.46
Inductance	mH	1.867	4.86
<b>Mechanical</b>			
Inertia	lb-in-s <sup>2</sup>	0.0349	0.0349
	Kg-cm <sup>2</sup>	39.431	39.431
Maximum Speed	rpm	4000	4000
Number of Motor Poles		8	8
Weight	lbs/Kg	77/35	77/35

① A blower cooling option is available which will increase the motor's continuous stall torque by another 60%.

# Brushless Servo C-Series

24

The BSM C Series of servo motors provide higher inertia in an economical package. These motors have a reliable magnetic design, and are used in applications needing higher inertial matching. These rugged motors provide peak torques equal to three times continuous, thus enabling rapid acceleration for the higher inertial demanding applications. Besides a wide variety of feedback devices, other options such as brakes and cooling to extend performance, mounting, shaft and electrical windings are available for your application needs. Baldor also has stocked motors for immediate delivery for your application needs.

Motor Family	Size		Torque Range	
	mm	in	lb-in	Nm
BSM80	89	3.5	10-38	1.2-4.3
BSM90	120	4.7	23-69	2.6-7.8
BSM100	146	5.7	44-265	5-30
BSM132	244	9.6	469-1185	53-134



BSM C

Variety of feedback options:

- › Resolver
- › Incremental/Absolute Encoders
- › Hall sensors

Stock and custom shafts and mountings. Rugged industrial construction - quality in the design.

- › IEC and NEMA
- › Design interchangeable with N-Series - versatility for machine designs.

High continuous rated operating temperature. Over temperature protective thermal switch.

Proven reliable bearings. 4 times longer bearing life.

O-rings for moisture and dust resistance. Rugged design for rugged environments - quality in the design.

Higher rotor inertia - for matching heavier machine inertial loads.

Optional holding brakes.

High voltage insulation. Windings potted for additional voltage protection - for improved reliability and improved heat transfer.

Optional shaft seal.

Rugged Construction

- › Sealed to IP60
- › With shaft oil seal sealed to IP65
- › 95% RH Non-Condensing
- › 1000 m (3300 Feet) without derate

Optional forced air cooling on some models - to extend torque capability for additional motor performance.

Typical BSM 90/100 series shown

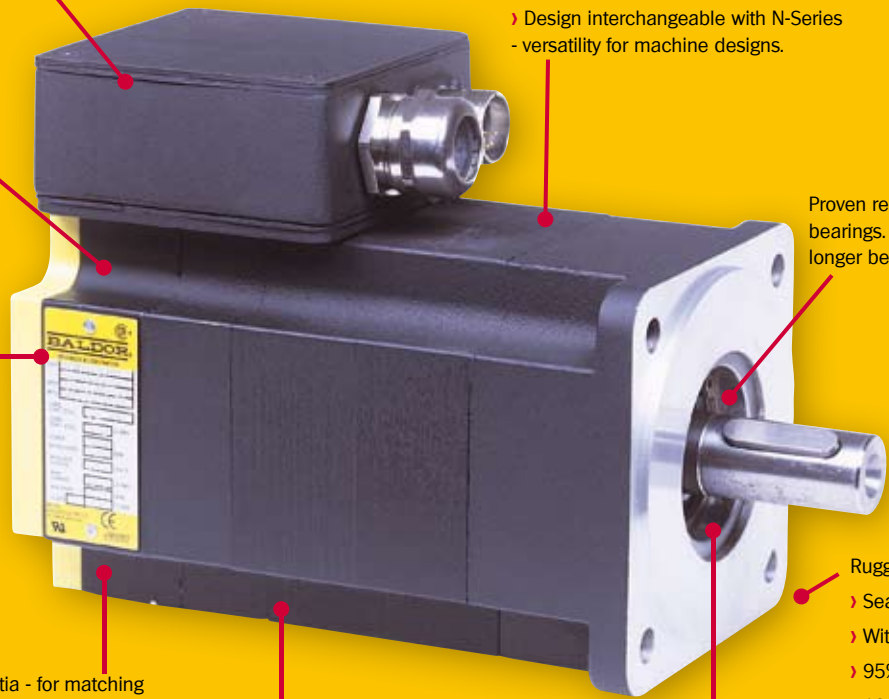





## BSM C-Series

The BSM C-Series has as standard, a “higher” inertia - thus providing an excellent match for equipment requiring higher inertial matching for the machine. This series provides continuous stall capability ranging from 10 lb-In (1.2 N-m) to 1185 lb-In (134 N-m). Peak torques are typically three times continuous. Baldor’s BSM C-series provides up to 50% more torque in a smaller size (2 inches/50 mm shorter) compared to previous Baldor models. The C-Series provides an economical package best used in applications with higher load inertias.

## AC Servo Motors - C-Series

Continuous Stall Torque		Continuous Stall Amps	Speed RPM @ 320V ①	Motor Number ②	Motor Inertia	
Lb-In	Nm				Lb-In-S <sup>2</sup>	Kg - cm <sup>2</sup>
10.6	1.2	2.7 1.9	6000 4000	BSM80C-150AX BSM80C-175AX	0.0016	1.81
21.2	2.4	5.2 3.2 1.6	6000 4000 2000	BSM80C-250AX BSM80C-275AX BSM80C-2150AX	0.0033	3.73
23.0	2.1	2.1	2000	BSM90C-1150AX	0.0039	4.4
31.8	3.6	7.8 6.3 3.2	6000 4000 2000	BSM80C-350AX BSM80C-375AX BSM80C-3150AX	0.0049	5.61
38.0	4.3	6.3 3.1	4000 2000	BSM80C-475AX BSM80C-4150AX	0.0066	7.45
44.3	5.0	4.0 2.3	2400 1200	BSM100C-1150AX BSM100C-1250AX	0.0149	16.82
46.0	5.2	9.0 4.7 2.5	4000 2000 1200	BSM90C-275AX BSM90C-2150AX BSM90C-2250AX	0.0078	8.81
69.0	7.8	12.0 6.0 3.4	4000 2000 1200	BSM90C-375AX BSM90C-3150AX BSM90C-3250AX	0.0117	13.2
88.5	10.0	8.0 4.9	2400 1200	BSM100C-2150AX BSM100C-2250AX	0.0299	33.7
125.7	14.2	11.4 6.9	2400 1200	BSM100C-3150AX BSM100C-3250AX	0.0448	50.6
177.0	20.0	16.8 10.6	2400 1200	BSM100C-4150AX BSM100C-4250AX	0.0598	67.5
221.3	25.0	21.0 13.0	2400 1200	BSM100C-5150AX BSM100C-5250AX	0.0747	84.4
265.5	30.0	24.0 14.1	2000 1200	BSM100C-6150AX BSM100C-6250AX	0.0897	101.2
469	53	37	1800	BSM132C-3200AX	0.233	262
619	70	43	1800	BSM132C-4200AX	0.287	324
770	87	50	1800	BSM132C-5200AX	0.345	389
929	105	52	1800	BSM132C-6200AX	0.392	443
1008	114	72	1800	BSM132C-7200AX	0.448	506
1097	124	74	1800	BSM132C-8200AX	0.513	579
1185	134	79	1800	BSM132C-9200AX	0.57	644

NOTE: ① Nominal rpm shown at 320 VDC bus for convenience. For 640 VDC double the speed. Reference motor table to verify that max speed is not exceeded. ② For X callouts, see motor ID matrix under engineering information.

# BSM C-Series Performance Curves

26

**BSM80C-150**

**BSM80C-175**

**BSM80C-250**

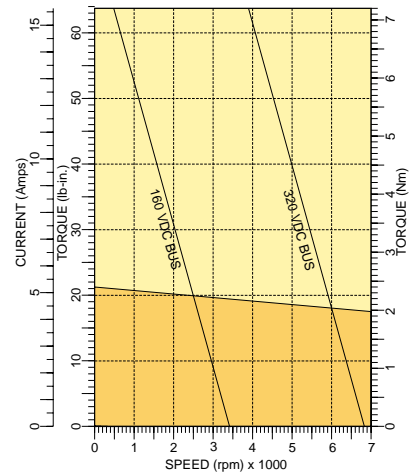
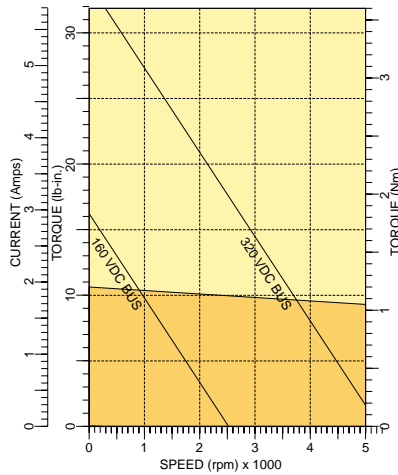
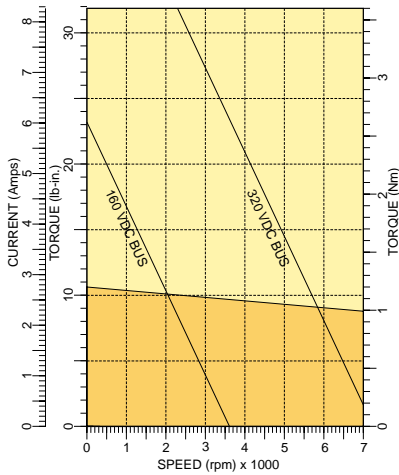

BSM C

Model Number		BSM80C-150	BSM80C-175	BSM80C-250
<b>General</b>				
Continuous Stall Torque	lb-in	10.6	10.6	21.2
	N-m	1.2	1.2	2.4
Continuous Current	amps	2.75	1.93	5.2
Peak Torque	lb-in	31.9	31.9	63.7
	N-m	3.6	3.6	7.2
Peak Current	amps	7.0	4.9	13.3
Thermal Resistance	°C/watt	1.33	1.33	1.15
Thermal Time Constant	Min	19	19	23
Mechanical Time Constant	msec	5.95	5.96	3.59
Electrical Time Constant	msec	1.63	1.65	2.79
Rated Speed @300 volts	rpm	6000	4000	6000
Rated Speed @600 volts	rpm	--	8000	--
<b>Electrical</b>				
Torque Constant	lb-in/amp	4.5	6.5	4.8
	N-m/amp	0.51	0.73	0.54
Voltage Constant	Vpk/krpm	43.7	62.5	46.2
	Vrms/krpm	30.9	44.2	32.7
Resistance	ohms	8.6	17.6	2.8
Inductance	mH	14	29.1	7.8
<b>Mechanical</b>				
Inertia	lb-in-s <sup>2</sup>	0.0016	0.0016	0.0033
	Kg-cm <sup>2</sup>	1.81	1.81	3.73
Maximum Speed	rpm	10,000	10,000	10,000
Number of Motor Poles		4	4	4
Weight	lbs/Kg	9/4.1	9/4.1	10/4.5

## BSM80C-275

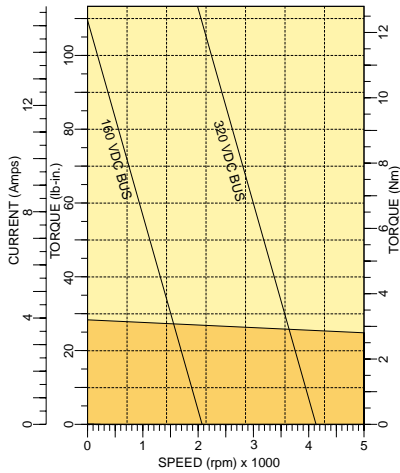

## BSM80C-2150

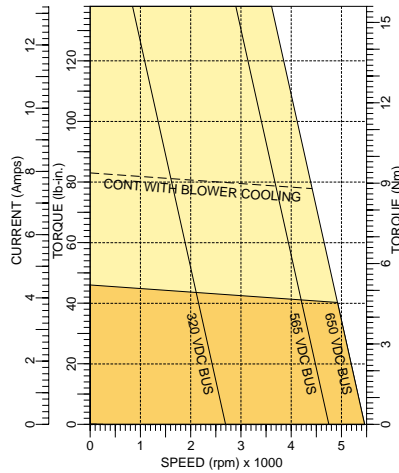

## BSM80C-350

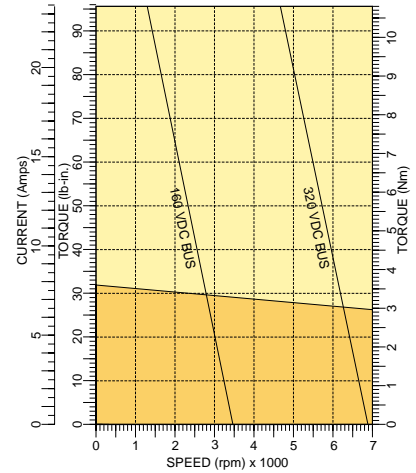

Model Number		BSM80C-275	BSM80C-2150	BSM80C-350
<b>General</b>				
Continuous Stall Torque	lb-in	21.2	21.2	31.9
	N-m	2.4	2.4	3.6
Continuous Current	amps	3.24	1.82	7.8
Peak Torque	lb-in	63.7	63.7	95.6
	N-m	7.2	7.2	10.8
Peak Current	amps	8.3	4.3	19.3
Thermal Resistance	°C/watt	1.15	1.15	1.0
Thermal Time Constant	Min	23	23	28
Mechanical Time Constant	msec	3.54	3.59	2.63
Electrical Time Constant	msec	2.63	2.81	3.02
Rated Speed @300 volts	rpm	4000	2000	6000
Rated Speed @600 volts	rpm	8000	4000	--
<b>Electrical</b>				
Torque Constant	lb-in/amp	7.7	14.5	4.8
	N-m/amp	0.87	1.64	0.54
Voltage Constant	Vpk/krpm	74.5	140.4	46.2
	Vrms/krpm	52.7	99.3	32.7
Resistance	ohms	7.2	26.6	1.39
Inductance	mH	18.9	73.3	4.2
<b>Mechanical</b>				
Inertia	lb-in-s <sup>2</sup>	0.0033	0.0033	0.00497
	Kg-cm <sup>2</sup>	3.73	3.73	5.53
Maximum Speed	rpm	10,000	10,000	10,000
Number of Motor Poles		4	4	4
Weight	lbs/Kg	10/4.5	10/4.5	11/5.0

# BSM C-Series Performance Curves

28

## BSM80C-375

## BSM80C-3150

## BSM80C-475

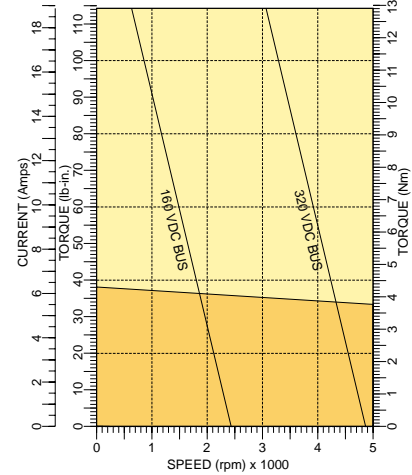
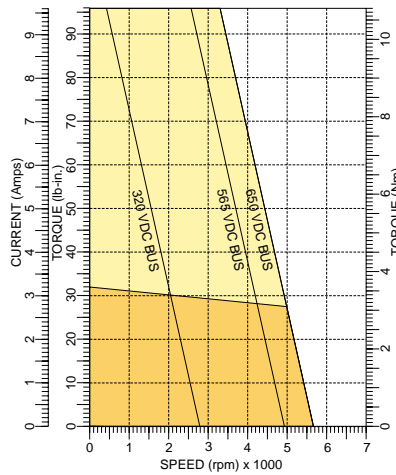
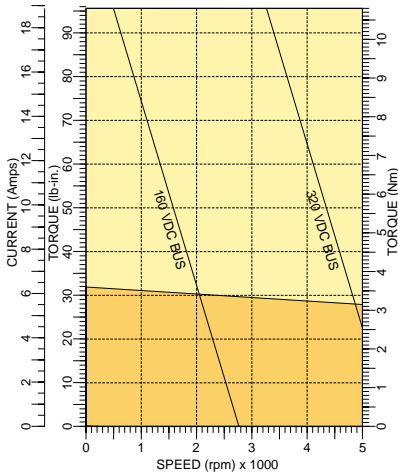

BSM C

Model Number		BSM80C-375	BSM80C-3150	BSM80C-475
<b>General</b>				
Continuous Stall Torque	lb-in	31.9	31.9	38.1
	N-m	3.6	3.6	4.3
Continuous Current	amps	6.29	3.2	6.3
Peak Torque	lb-in	95.6	95.6	114.2
	N-m	10.8	10.8	12.9
Peak Current	amps	16.0	8.1	17.0
Thermal Resistance	°C/watt	1.0	1.0	1.0
Thermal Time Constant	Min	28	28	32
Mechanical Time Constant	msec	2.7	2.7	2.42
Electrical Time Constant	msec	3.73	3.69	3.16
Rated Speed @300 volts	rpm	4000	2000	4000
Rated Speed @600 volts	rpm	8000	4000	8000
<b>Electrical</b>				
Torque Constant	lb-in/amp	6.0	11.8	6.7
	N-m/amp	0.67	1.33	0.76
Voltage Constant	Vpk/krpm	57.5	113.8	65.2
	Vrms/krpm	40.7	80.5	46.0
Resistance	ohms	2.2	8.9	1.95
Inductance	mH	8.2	32.8	6.0
<b>Mechanical</b>				
Inertia	lb-in-s <sup>2</sup>	0.00497	0.00497	0.0066
	Kg-cm <sup>2</sup>	5.53	5.53	7.45
Maximum Speed	rpm	10,000	10,000	10,000
Number of Motor Poles		4	4	4
Weight	lbs/Kg	13/5.9	13/5.9	16/7.2

# BSM C-Series Performance Curves

**BSM80C-4150**

**BSM90C-1150**

**BSM90C-275**

29

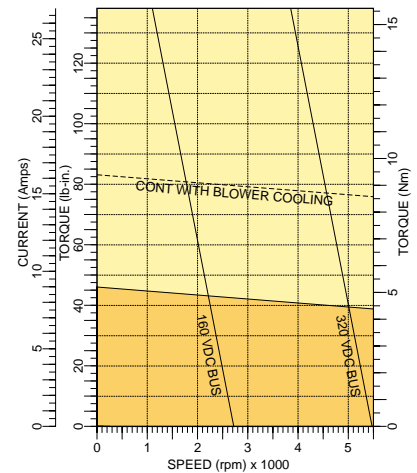
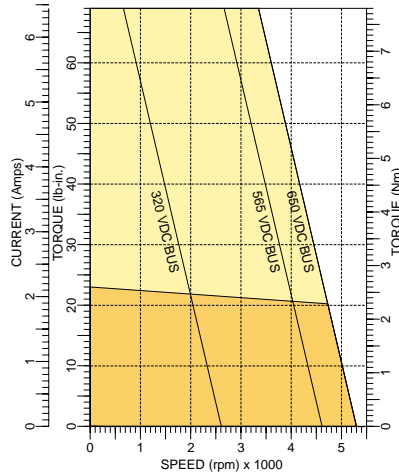
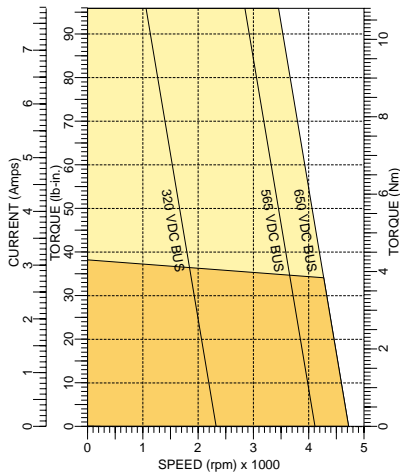

BSM C

Model Number		BSM80C-4150	BSM90C-1150	BSM90C-275 ①
<b>General</b>				
Continuous Stall Torque	lb-in	38.1	23	46.0
	N-m	4.3	2.6	5.2
Continuous Current	amps	3.17	2.15	9
Peak Torque	lb-in	114.2	69.0	138.1
	N-m	12.9	7.8	15.6
Peak Current	amps	8.1	5.47	23.0
Thermal Resistance	°C/watt	1.0	1.6	0.9
Thermal Time Constant	Min	32	35	45
Mechanical Time Constant	msec	2.03	2.52	1.0
Electrical Time Constant	msec	3.93	2.40	3.56
Rated Speed @300 volts	rpm	2000	2000	4000
Rated Speed @600 volts	rpm	4000	4000	8000
<b>Electrical</b>				
Torque Constant	lb-in/amp	14.1	12.6	6.0
	N-m/amp	1.59	1.42	0.68
Voltage Constant	Vpk/krpm	136.5	121.8	58.3
	Vrms/krpm	96.5	86.1	41.2
Resistance	ohms	7	11.5	1.04
Inductance	mH	27.5	27.6	3.7
<b>Mechanical</b>				
Inertia	lb-in-s <sup>2</sup>	0.0066	0.0039	0.0078
	Kg-cm <sup>2</sup>	7.45	4.40	8.81
Maximum Speed	rpm	10,000	10,000	10,000
Number of Motor Poles		4		8
Weight	lbs/Kg	16/7.2	17/7.7	23/10.5

① A blower cooling option is available which will increase the motor's continuous stall torque by another 80%.

# BSM C-Series Performance Curves

30

**BSM90C-2150**

**BSM90C-2250**

**BSM90C-375**

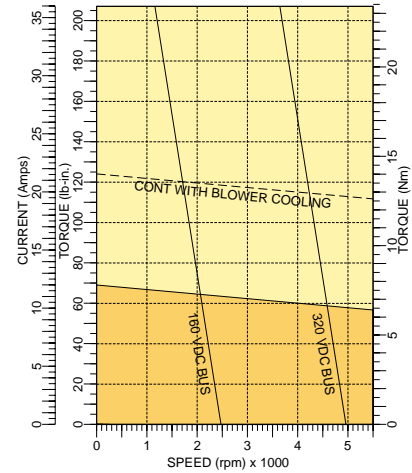
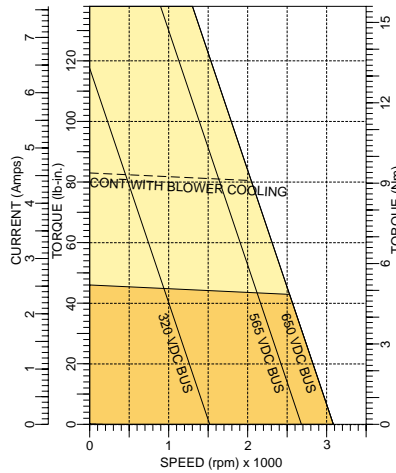
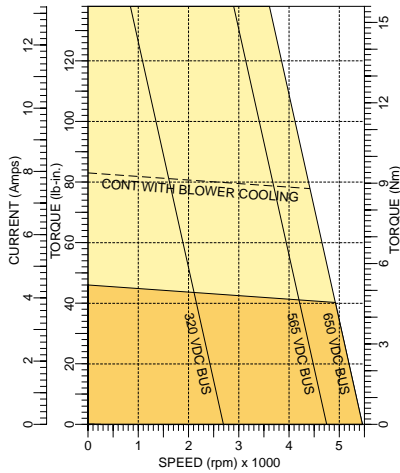

BSM C

Model Number		BSM90C-2150 ①	BSM90C-2250 ①	BSM90C-375 ①
<b>General</b>				
Continuous Stall Torque	lb-in	46.0	46.0	69.0
	N-m	5.2	5.2	7.8
Continuous Current	amps	4.78	2.51	12
Peak Torque	lb-in	138.1	138.1	207.1
	N-m	15.6	15.6	23.4
Peak Current	amps	12.2	6.4	30.8
Thermal Resistance	°C/watt	0.9	0.9	0.87
Thermal Time Constant	Min	45	45	55
Mechanical Time Constant	msec	2.32	2.38	1.59
Electrical Time Constant	msec	2.96	3.29	3.84
Rated Speed @300 volts	rpm	2000	1200	4000
Rated Speed @600 volts	rpm	4000	2400	8000
<b>Electrical</b>				
Torque Constant	lb-in/amp	12.2	21.6	6.7
	N-m/amp	1.38	2.44	0.76
Voltage Constant	Vpk/krpm	118.8	208.6	64.9
	Vrms/krpm	84	147.5	45.9
Resistance	ohms	5	16	0.69
Inductance	mH	14.8	52.7	2.65
<b>Mechanical</b>				
Inertia	lb-in-s <sup>2</sup>	0.0078	0.0078	0.0117
	Kg-cm <sup>2</sup>	8.81	8.81	13.21
Maximum Speed	rpm	10,000	10,000	10,000
Number of Motor Poles		8	8	8
Weight	lbs/Kg	23/10.5	23/10.5	30/13.6

① A blower cooling option is available which will increase the motor's continuous stall torque by another 80%.



# BSM C-Series Performance Curves

**BSM90C-3150**

**BSM90C-3250**

**BSM100C-1150**

31

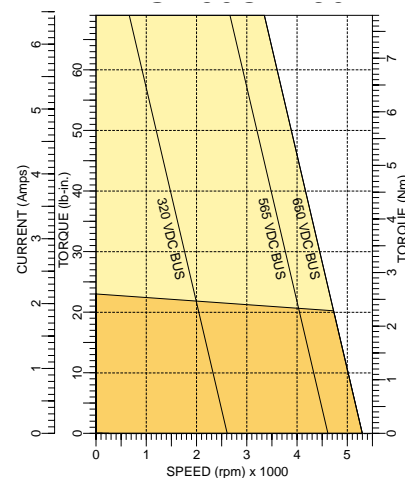
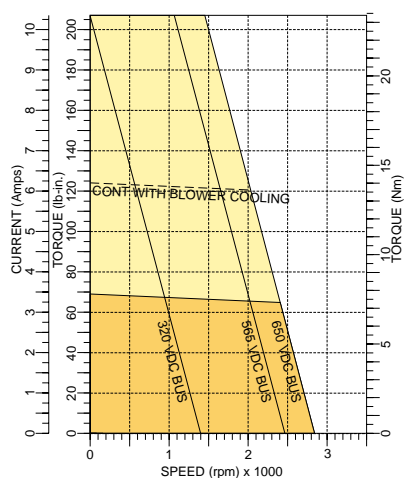
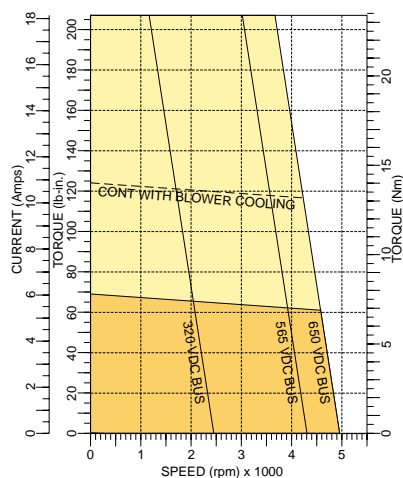

BSM C

Model Number		BSM90C-3150 ①	BSM90C-3250 ①	BSM100C-1150
<b>General</b>				
Continuous Stall Torque	lb-in	69.0	69.0	44.3
	N-m	7.8	7.8	5
Continuous Current	amps	6	3.45	4.01
Peak Torque	lb-in	207.1	207.1	132.8
	N-m	23.4	23.4	15
Peak Current	amps	15.4	8.8	10.2
Thermal Resistance	°C/watt	0.87	0.87	1.04
Thermal Time Constant	Min	55	55	47
Mechanical Time Constant	msec	1.55	1.84	4.12
Electrical Time Constant	msec	4.22	3.32	3.69
Rated Speed @300 volts	rpm	2000	1200	2400
Rated Speed @600 volts	rpm	4000	2400	4800
<b>Electrical</b>				
Torque Constant	lb-in/amp	13.4	23.5	12.9
	N-m/amp	1.52	2.65	1.46
Voltage Constant	Vpk/krpm	129.8	227.1	125.0
	Vrms/krpm	91.8	160.6	88.4
Resistance	ohms	2.7	9.77	5.2
Inductance	mH	11.4	32.4	19.2
<b>Mechanical</b>				
Inertia	lb-in-s <sup>2</sup>	0.0117	0.0117	0.0149
	Kg-cm <sup>2</sup>	13.21	13.21	16.82
Maximum Speed	rpm	10,000	10,000	7000
Number of Motor Poles		8	8	8
Weight	lbs/Kg	30/13.6	30/13.6	30/13.6

① A blower cooling option is available which will increase the motor's continuous stall torque by another 80%.

# BSM C-Series Performance Curves

32

**BSM100C-1250**

**BSM100C-2150**

**BSM100C-2250**

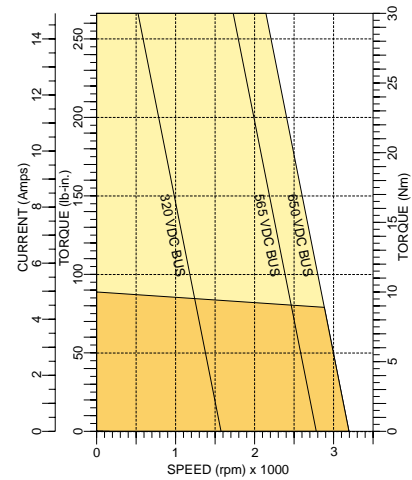
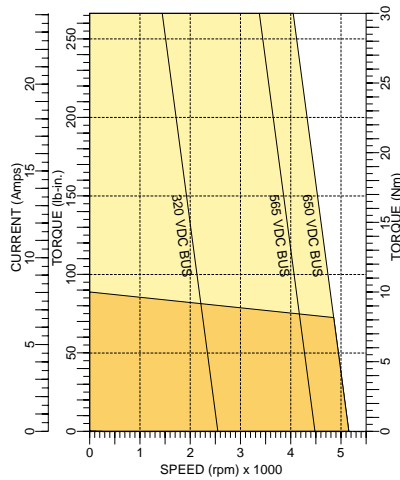
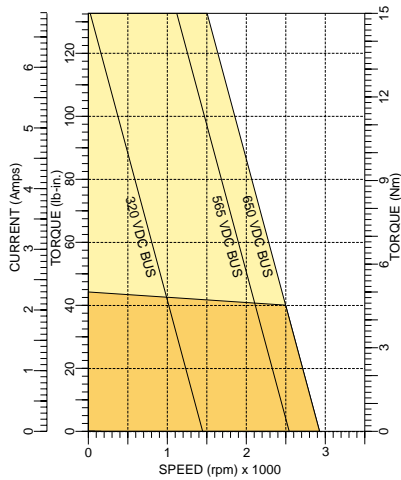

BSM C

Model Number		BSM100C-1250	BSM100C-2150	BSM100C-2250
<b>General</b>				
Continuous Stall Torque	lb-in	44.3	88.5	88.5
	N-m	5	10	10
Continuous Current	amps	2.3	8.02	4.97
Peak Torque	lb-in	132.8	265.5	265.5
	N-m	15	30	30
Peak Current	amps	5.8	20.4	12.7
Thermal Resistance	°C/watt	1.04	0.84	0.84
Thermal Time Constant	Min	47	54	54
Mechanical Time Constant	msec	3.71	2.54	2.56
Electrical Time Constant	msec	4.12	5.13	6.00
Rated Speed @300 volts	rpm	1200	2400	1200
Rated Speed @600 volts	rpm	2400	4800	2400
<b>Electrical</b>				
Torque Constant	lb-in/amp	22.7	12.9	20.9
	N-m/amp	2.57	1.46	2.36
Voltage Constant	Vpk/krpm	219.9	125.0	201.9
	Vrms/krpm	155.5	88.4	142.8
Resistance	ohms	14.5	1.6	4.2
Inductance	mH	59.8	8.2	25.2
<b>Mechanical</b>				
Inertia	lb-in-s <sup>2</sup>	0.0149	0.02991	0.02991
	Kg-cm <sup>2</sup>	16.82	33.77	33.77
Maximum Speed	rpm	7000	7000	7000
Number of Motor Poles		8	8	8
Weight	lbs/Kg	30/13.6	39/17.7	39/17.7

# BSM C-Series Performance Curves

## BSM100C-3150

## BSM100C-3250

33

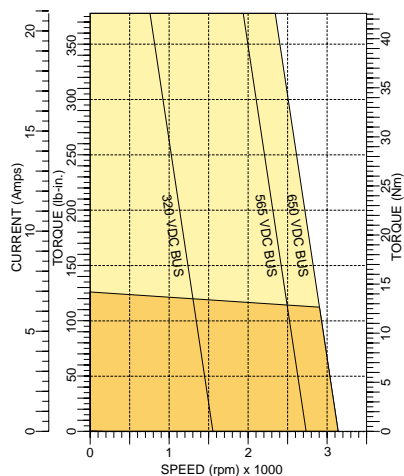
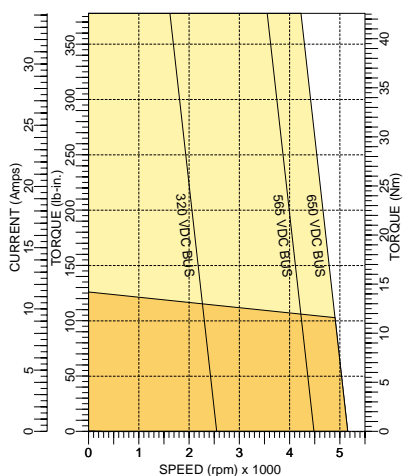

BSM C

Model Number		BSM100C-3150	BSM100C-3250
<b>General</b>			
Continuous Stall Torque	lb-in	125.7	125.7
	N-m	14.2	14.2
Continuous Current	amps	11.4	6.9
Peak Torque	lb-in	377.0	377.0
	N-m	42.6	42.6
Peak Current	amps	29.0	17.7
Thermal Resistance	°C/watt	0.8	0.8
Thermal Time Constant	Min	62	62
Mechanical Time Constant	msec	2.00	1.94
Electrical Time Constant	msec	7.62	7.86
Rated Speed @300 volts	rpm	2400	1200
Rated Speed @600 volts	rpm	4800	2400
<b>Electrical</b>			
Torque Constant	lb-in/amp	12.9	21.2
	N-m/amp	1.46	2.40
Voltage Constant	Vpk/krpm	125.0	205.3
	Vrms/krpm	88.4	145.2
Resistance	ohms	0.84	2.2
Inductance	mH	6.4	17.3
<b>Mechanical</b>			
Inertia	lb-in-s <sup>2</sup>	0.04487	0.04487
	Kg-cm <sup>2</sup>	50.66	50.66
Maximum Speed	rpm	7000	7000
Number of Motor Poles		8	8
Weight	lbs/Kg	50/22.7	50/22.7

# BSM C-Series Performance Curves

34

**BSM100C-4150**

**BSM100C-4250**

**BSM100C-5150**

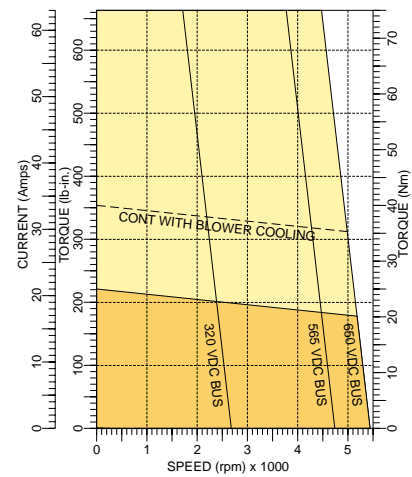
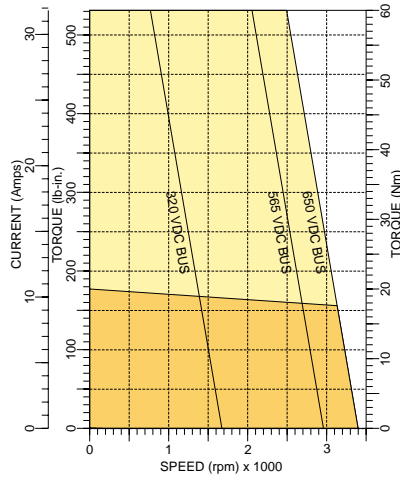
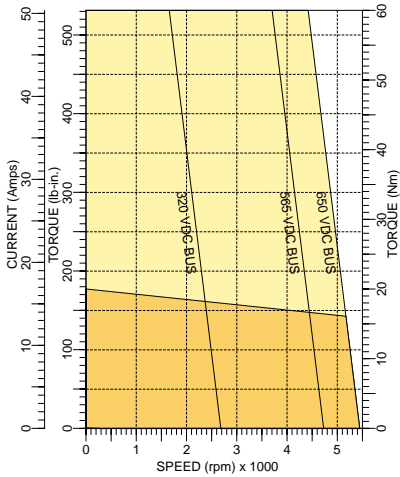

BSM C

Model Number		BSM100C-4150	BSM100C-4250	BSM100C-5150 ①
<b>General</b>				
Continuous Stall Torque	lb-in	177.0	177.0	221.3
	N-m	20	20	25
Continuous Current	amps	16.8	10.6	21
Peak Torque	lb-in	531.0	531.0	663.8
	N-m	60	60	75
Peak Current	amps	42.9	26.9	53.6
Thermal Resistance	°C/watt	0.53	0.53	0.48
Thermal Time Constant	Min	70	70	77
Mechanical Time Constant	msec	2.00	2.06	1.80
Electrical Time Constant	msec	7.54	7.47	8.54
Rated Speed @ 300 volts	rpm	2400	1200	2400
Rated Speed @600 volts	rpm	4800	2400	4000
<b>Electrical</b>				
Torque Constant	lb-in/amp	12.3	19.6	12.3
	N-m/amp	1.39	2.22	1.39
Voltage Constant	Vpk/krpm	118.9	189.9	118.9
	Vrms/krpm	84.1	134.3	84.1
Resistance	ohms	0.57	1.5	0.41
Inductance	mH	4.3	11.2	3.5
<b>Mechanical</b>				
Inertia	lb-in-s <sup>2</sup>	0.05982	0.05982	0.07478
	Kg-cm <sup>2</sup>	67.54	67.54	84.43
Maximum Speed	rpm	7000	7000	7000
Number of Motor Poles		8	8	8
Weight	lbs/Kg	59/26.8	59/26.8	70/31.8

① A blower cooling option is available which will increase the motor's continuous stall torque by another 60%.

# BSM C-Series Performance Curves

**BSM100C-5250**

**BSM100C-6150**

**BSM100C-6250**

35

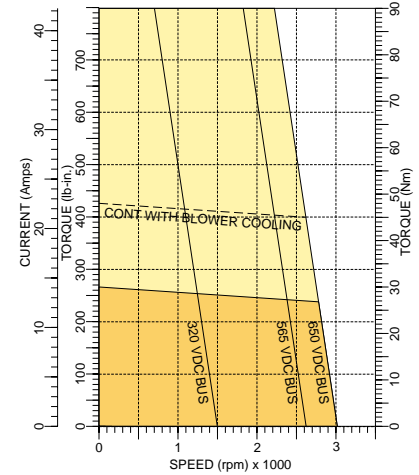
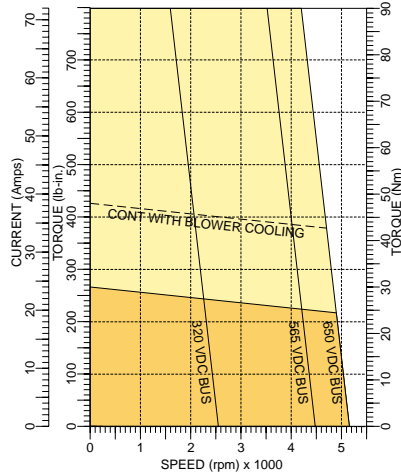
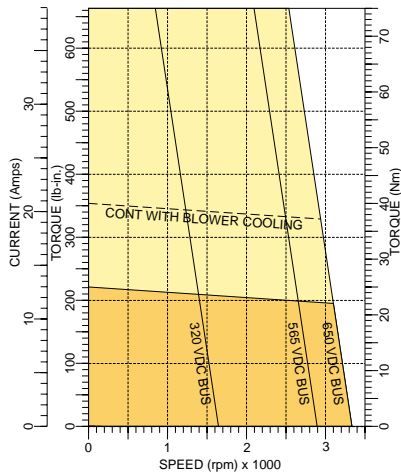

BSM C

Model Number		BSM100C-5250 ①	BSM100C-6150 ①	BSM100C-6250 ①
<b>General</b>				
Continuous Stall Torque	lb-in	221.3	265.5	265.5
	N-m	25	30	30
Continuous Current	amps	13	24	14.1
Peak Torque	lb-in	663.8	796.5	796.5
	N-m	75	90	90
Peak Current	amps	33.1	61.3	36
Thermal Resistance	°C/watt	0.48	0.34	0.34
Thermal Time Constant	Min	77	85	85
Mechanical Time Constant	msec	1.77	2.15	1.96
Electrical Time Constant	msec	8.60	5.78	6.00
Rated Speed @ 300 volts	rpm	1200	2000	1200
Rated Speed @600 volts	rpm	2400	4000	2400
<b>Electrical</b>				
Torque Constant	lb-in/amp	20.0	12.9	22.1
	N-m/amp	2.26	1.46	2.50
Voltage Constant	Vpk/krpm	193.4	125.0	213.9
	Vrms/krpm	136.8	88.4	151.3
Resistance	ohms	1.07	0.45	1.2
Inductance	mH	9.2	2.6	7.0
<b>Mechanical</b>				
Inertia	lb-in-s <sup>2</sup>	0.07478	0.0897	0.0897
	Kg-cm <sup>2</sup>	84.43	101.27	101.27
Maximum Speed	rpm	7000	7000	7000
Number of Motor Poles		8	8	8
Weight	lbs/Kg	70/31.8	81/36.8	81/36.8

① A blower cooling option is available which will increase the motor's continuous stall torque by another 60%.

# BSM C-Series Performance Curves

36

## BSM132C-3200AA

## BSM132C-4200AA

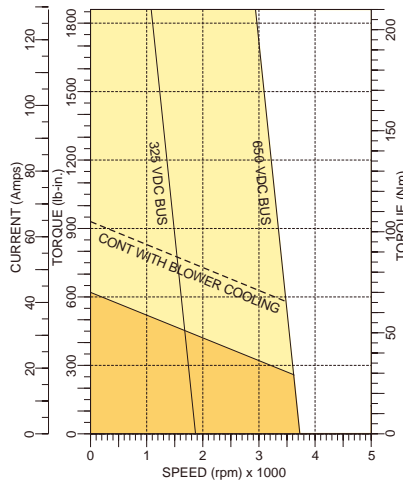
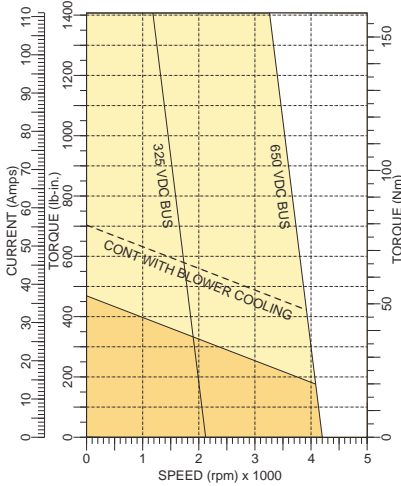

BSM C

Model Number		BSM132C-3200AA ①	BSM132-4200AA ①
<b>General</b>			
Continuous Stall Torque	lb-in	469.1	619.5
	N-m	53	70
Continuous Current	amps	37	43
Peak Torque	lb-in	1407	1859
	N-m	159	210
Peak Current	amps	110	129
Thermal Resistance	°C/watt	0.25	0.22
Thermal Time Constant	Min	112	116
Mechanical Time Constant	msec	1.67	1.66
Electrical Time Constant	msec	15.31	17.38
Nominal Speed @ 650VDC bus	rpm	3500	3500
Nominal Speed @ 325VDC bus	rpm	1800	1800
<b>Electrical</b>			
Torque Constant	lb-in/amp	16.0	18.0
	N-m/amp	1.80	2.03
Voltage Constant	Vpk/krpm	154.6	174.0
	Vrms/krpm	109.4	123.0
Resistance	ohms	0.26	0.21
Inductance	mH	3.98	3.65
<b>Mechanical</b>			
Inertia	lb-in-s <sup>2</sup>	0.185	0.287
	Kg-cm <sup>2</sup>	208.865	324.023
Maximum Speed	rpm	5000	5000
Number of Motor Poles		8	8
Weight	lbs/Kg	119/54.1	123/55.9

① A blower cooling option is available which will increase the motor's continuous stall torque by another 45%.



# BSM C-Series Performance Curves

**BSM132C-5200AA**

**BSM132C-6200AA**

**BSM132C-7200AA**

37

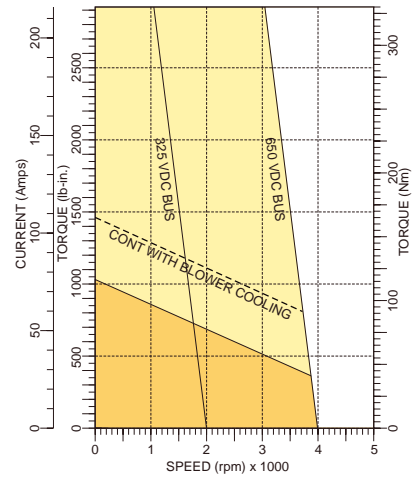
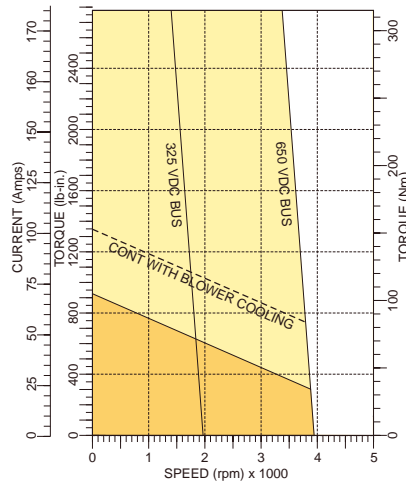
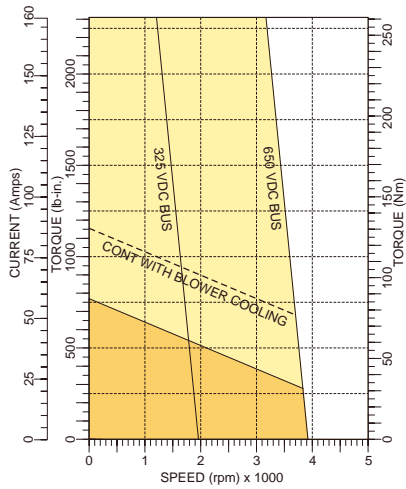

BSM C

Model Number		BSM132C-5200AA ①	BSM132C-6200AA ①	BSM132C-7200AA ①
<b>General</b>				
Continuous Stall Torque	lb-in	770.0	929.3	1008.9
	N-m	87	105	114
Continuous Current	amps	58	71	75
Peak Torque	lb-in	2310	2788	3027
	N-m	261	315	342
Peak Current	amps	174	212	225
Thermal Resistance	°C/watt	0.17	0.17	0.17
Thermal Time Constant	Min	120	124	128
Mechanical Time Constant	msec	2.91	2.03	1.22
Electrical Time Constant	msec	15.31	25.25	30.46
Nominal Speed @ 650VDC bus	rpm	3500	3500	3500
Nominal Speed @ 325VDC bus	rpm	1800	1800	1800
<b>Electrical</b>				
Torque Constant	lb-in/amp	16.5	16.5	16.8
	N-m/amp	1.87	1.86	1.9
Voltage Constant	Vpk/krpm	160.3	159.4	162.8
	Vrms/krpm	113.3	112.7	115.2
Resistance	ohms	0.26	0.16	0.087
Inductance	mH	3.98	3.99	2.65
<b>Mechanical</b>				
Inertia	lb-in-s <sup>2</sup>	0.345	0.392	0.448
	Kg-cm <sup>2</sup>	389.505	442.568	505.792
Maximum Speed	rpm	5000	5000	5000
Number of Motor Poles		8	8	8
Weight	lbs/Kg	148/67.3	172/78.2	191/86.8

① A blower cooling option is available which will increase the motor's continuous stall torque by another 45%.

# BSM C-Series Performance Curves

38

**BSM132C-8200AA**

**BSM132C-9200AA**

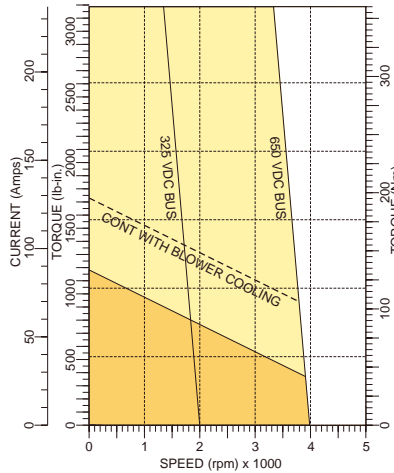
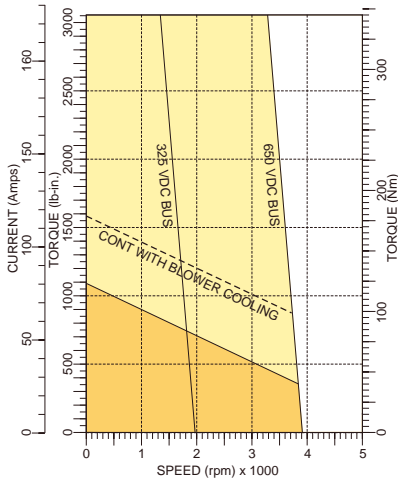

BSM C

Model Number		BSM132C-8200AA ①	BSM132C-9200AA ①
<b>General</b>			
Continuous Stall Torque	lb-in	1097.4	1185.9
	N-m	124	134
Continuous Current	amps	80	88
Peak Torque	lb-in	3292	3558
	N-m	372	402
Peak Current	amps	240	264
Thermal Resistance	°C/watt	0.17	0.17
Thermal Time Constant	Min	132	136
Mechanical Time Constant	msec	1.08	1.18
Electrical Time Constant	msec	32.86	26.21
Nominal Speed @ 650VDC bus	rpm	3500	3500
Nominal Speed @ 325VDC bus	rpm	1800	1800
<b>Electrical</b>			
Torque Constant	lb-in/amp	17.2	16.8
	N-m/amp	1.94	1.9
Voltage Constant	Vpk/krpm	166.3	162.8
	Vrms/krpm	117.6	115.2
Resistance	ohms	0.07	0.066
Inductance	mH	2.3	1.73
<b>Mechanical</b>			
Inertia	lb-in-s <sup>2</sup>	0.513	0.57
	Kg-cm <sup>2</sup>	579.177	643.53
Maximum Speed	rpm	5000	5000
Number of Motor Poles		8	8
Weight	lbs/Kg	210/95.5	229/104.1

① A blower cooling option is available which will increase the motor's continuous stall torque by another 45%.

# Brushless Servo Motors

## BSM Series Dimensions - IEC Mountings

### BSM50 Series

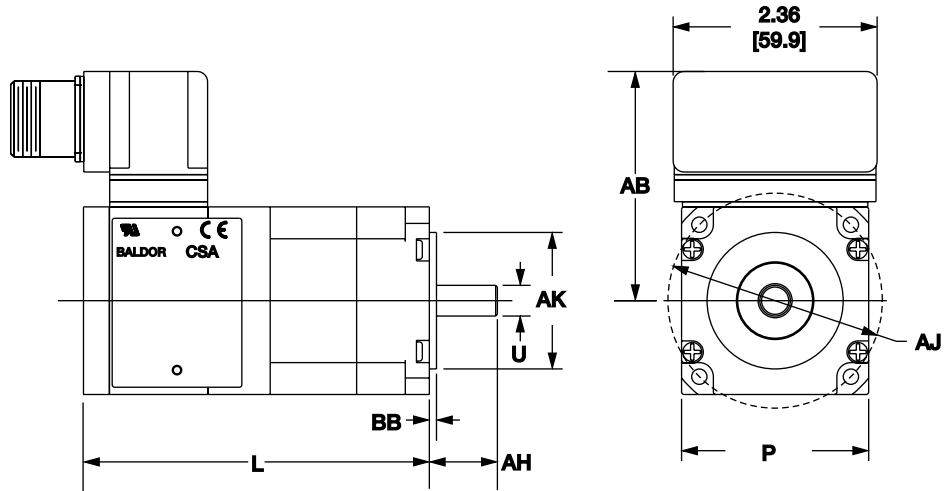

### BSM63/80 Series

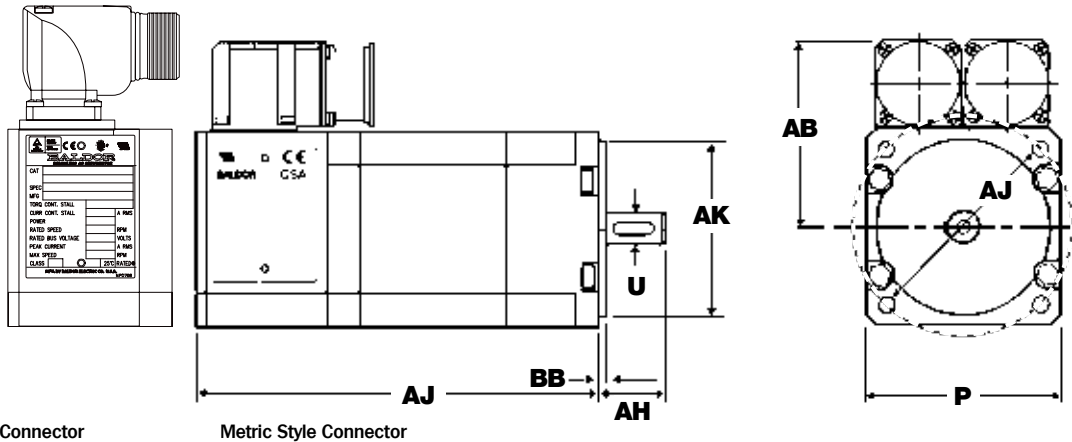

Rotatable Connector

Metric Style Connector

Dimensions N & C

### BSM90/100 Series

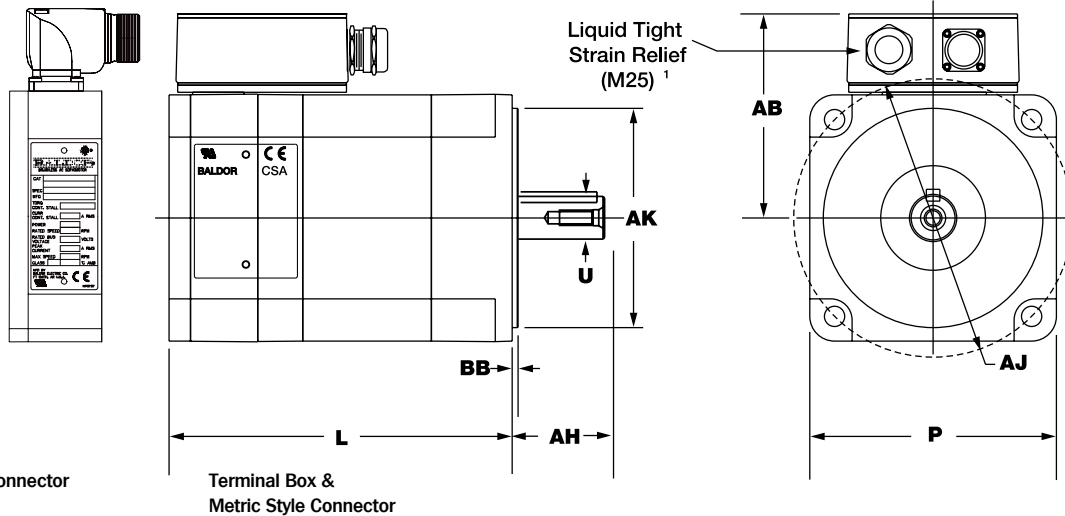

Rotatable Connector

Terminal Box & Metric Style Connector

**NOTE:** M25 Strain Relief is used on all BSM90/100 Series rated for 20 amps. Motors rated for greater than 20 amps should use M40 strain relief (P/N MCS-M40) and M40/M25 adaptor (P/N MCS-M40A). Shipped with cable assembly. Rotatable connector not available on BSM50.

# Brushless Servo Motors

## BSM Series Dimensions - IEC Mountings

### BSM 132 Series

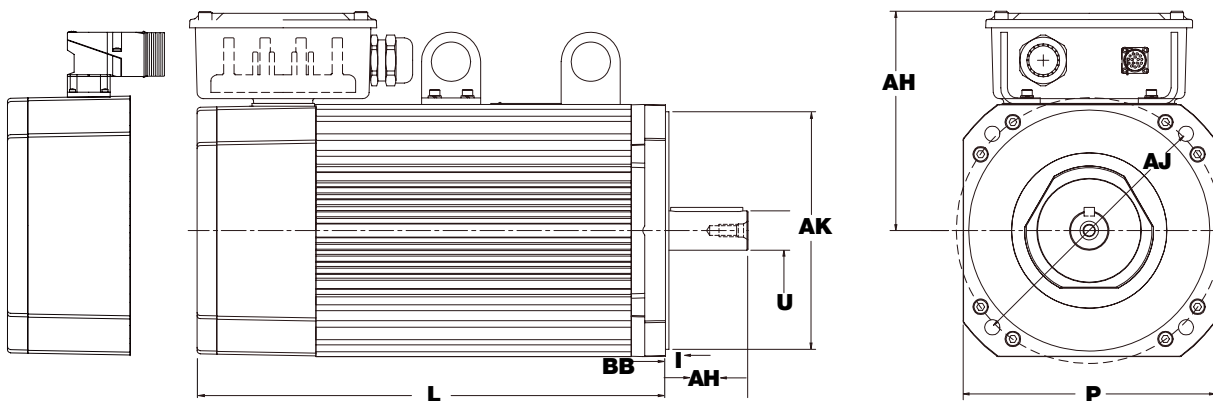

Rotatable Connector

Terminal Box & Metric Style Connector

# BSM Series Dimensions - IEC Mountings

Dimensions in mm (inch)

Motor Code	P	AB	U	AH	Key	AJ	AK	BB
BSM50N	55 (2.17)	67 (2.64)	9j6 (0.35)	20 (0.78)	None	4.5mm thru hole 63mm B.C.	40j6 (1.5)	2.5 (0.098)
BSM63N	67 (2.6)	65 (2.6)	11j6 (0.43)	23 (0.9)	4x4x12	5.8mm thru hole 75mm B.C.	60j6 (2.3)	2.5 (0.098)
BSM80N/C	89 (3.5)	76 (3.0)	19j6 (0.74)	40 (1.5)	6x6x25	7.0mm thru hole 100mm B.C.	80j6 (3.1)	3.0 (0.118)
BSM90N/C	120 (4.7)	109 (4.3)	24j6 (0.94)	50 (2.0)	8x7x36	10mm thru hole 130mm B.C.	110j6 (4.3)	3.5 (0.138)
BSM100N/C	146 (5.7)	122 (4.8)	28j6 (1.1)	60 (2.3)	8x7x50	12mm thru hole 165mm B.C.	130j6 (5.1)	3.5 (0.138)
BSM132C	244 (9.6)	212 (8.35)	38 (1.49)	80 (3.1)	10x8x70	14.5mm thru hole 265mm B.C.	230 (9)	3.5 (0.138)

Motor Code	Length - L		Motor Code	Length - L	
	Resolver	Encoder		Resolver	Encoder
BSM50N-1	101.7 (4.0)	128.7 (5.07)	BSM80C-1	144.0 (5.67)	144.0 5.67
BSM50N-2	127.1 (5.0)	154.1 (6.07)	BSM80C-2	169.4 (6.67)	169.4 6.67
BSM50N-3	152.5 (6.0)	179.5 (7.07)	BSM80C-3	194.8 (7.67)	194.8 7.67
BSM63N-1	115.8 (4.56)	125.9 (4.96)	BSM80C-4	220.2 (8.67)	220.2 8.67
BSM63N-2	141.2 (5.56)	151.3 (5.96)	BSM90C-1	164.7 (6.49)	164.7 (6.49)
BSM63N-3	166.6 (6.56)	176.7 (6.96)	BSM90C-2	202.8 (7.99)	202.8 (7.99)
BSM80N-1	150.7 (5.93)	150.7 (5.93)	BSM90C-3	240.9 (9.49)	240.9 (9.49)
BSM80N-2	182.5 (7.18)	182.5 (7.18)	BSM100C-1	164.7 (6.49)	164.7 (6.49)
BSM80N-3	214.2 (8.43)	214.2 (8.43)	BSM100C-2	202.8 (7.99)	202.8 (7.99)
BSM90N-1	177.4 (6.99)	177.4 (6.99)	BSM100C-3	240.9 (9.49)	240.9 (9.49)
BSM90N-2	228.2 (8.99)	228.2 (8.99)	BSM100C-4	279.0 (10.99)	279.0 (10.99)
BSM90N-3	279.0 (10.99)	279.0 (10.99)	BSM100C-5	317.1 (12.49)	317.1 (12.49)
BSM100N-1	203.1 (8.02)	203.1 (8.02)	BSM100C-6	355.2 (13.99)	355.2 (13.99)
BSM100N-2	253.9 (10.0)	253.9 (10.0)	BSM132C-3	384 (15.12)	384 (15.12)
BSM100N-3	304.7 (12.0)	304.7 (12.0)	BSM132C-4	409.4 (16.12)	409.4 (16.12)
BSM100N-4	355.5 (14.0)	355.5 (14.0)	BSM132C-5	434.8 (17.12)	434.8 (17.12)
			BSM132C-6	460.2 (18.12)	460.2 (18.12)
			BSM132C-7	485.6 (19.12)	485.6 (19.12)
			BSM132C-8	511 (20.12)	511 (20.12)
			BSM132C-9	536.4 (21.12)	536.4 (21.12)

**Note:** Standard configuration: All motors supplied with feedback device. Square mounting flange. See notes on page 90.

The motors have a threaded hole on the shaft end. The BSM63 series is M4 x 0.7 threads (11mm deep). The BSM80 series is M6 x 1.0 threads (17 mm deep). The BSM90 series is M6 x 1.0 threads (17 mm deep). The BSM100 series is M10 x 1.5 threads (23 mm deep). The BSM132 series is M12x1.5 threads (27 mm deep).

Dimensions are for reference only and may change for other selected option. Detailed engineering drawings are available upon request. Contact Baldor for dimensions with other feedback devices.

# BSM Series Dimensions - NEMA Mountings

42

## BSM50 Series NEMA 23

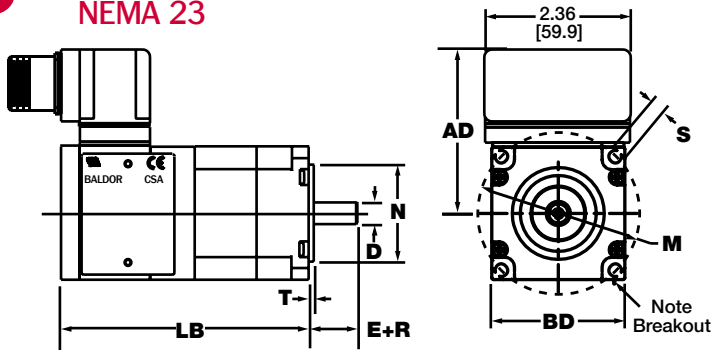

## Optional NEMA 23 Mounting

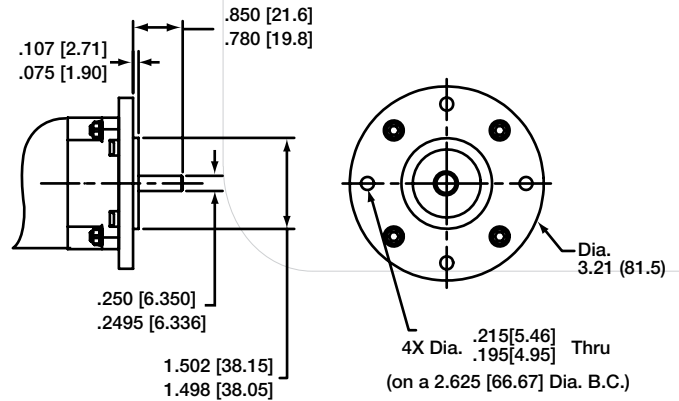

## BSM63/80 Series NEMA 34/42

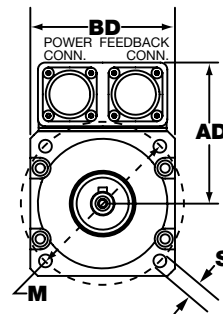
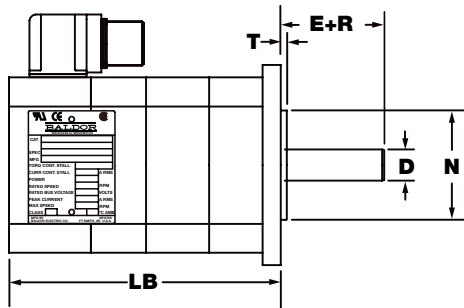

## BSM90/100 Series NEMA 56

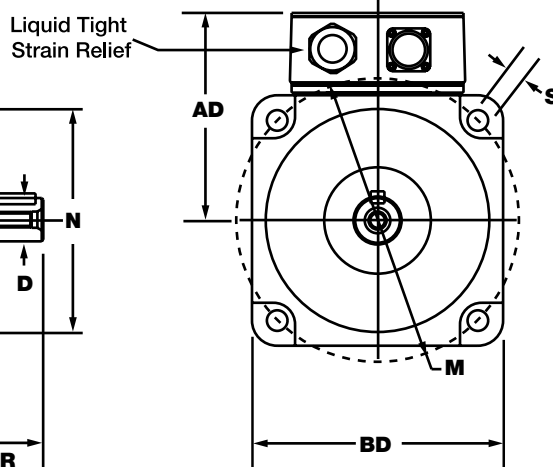
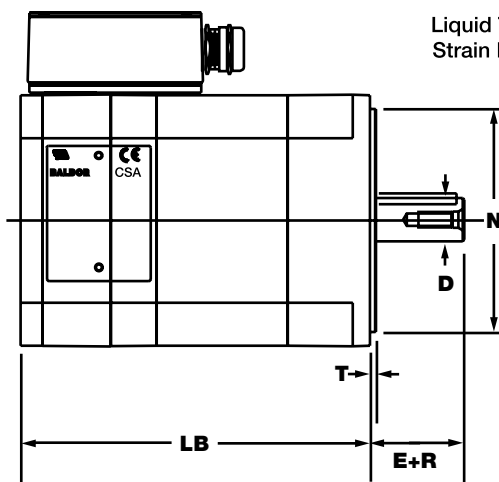

## NEMA Key Configuration

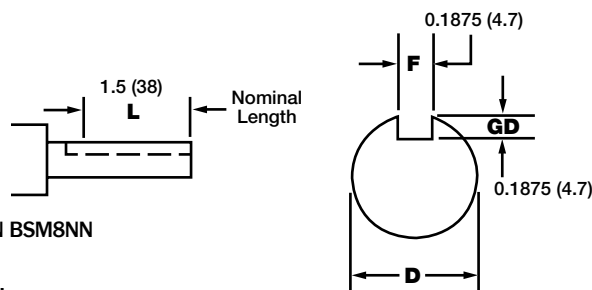

Note: Dimensions shown for BSM6NN BSM8NN and BSM9NN (NEMA 34, 42 & 56). BSM5NN has no keyway, as standard.



# Brushless Servo Motor Dimensions - NEMA Mountings

Dimensions in inch (mm)

NEMA Code	Motor Code	BD	AD	D	E + R	M	S thru	N	T
23	BSM5NN	2.2 (55)	2.64 (67)	0.25 (6.3)	0.812 (20)	2.625	0.2 Hole	1.5 (38)	0.10 (2.5)
34	BSM6NN	3.14 (80)	2.88 (73)	0.375 (9.5)	0.9 (22)	3.875	0.22 Hole	2.875 (73)	0.10 (2.5)
42	BSM8NN	4.0 (101)	3.0 (76)	0.625 (15)	2.0 (52)	4.95	0.28 Hole	2.187 (55)	0.10 (2.5)
42	BSM8NC	4.0 (101)	3.0 (76)	0.625 (15)	2.0 (52)	4.95	0.28 Hole	2.187 (55)	0.10 (2.5)
56	BSM9NN	5.17 (131)	4.3 (108)	0.625 (15)	2.0 (52)	5.875	0.375-16 THD	4.5 (114)	0.10 (2.5)
56	BSM9NC	5.17 (131)	4.3 (108)	0.625 (15)	2.0 (52)	5.875	0.375-16 THD	4.5 (114)	0.13 (3.3)
56	BSM10NN	5.75 (146)	4.8 (122)	0.625 (15)	2.0 (52)	5.875	0.375-16 THD	4.5 (114)	0.13 (3.3)
56	BSM10NC	5.75 (146)	4.8 (122)	0.625 (15)	2.0 (52)	5.875	0.375-16 THD	4.5 (114)	0.13 (3.3)

NEMA Code	Motor Code	Length - LB		Motor Code	Length - LB	
		Resolver	Encoder		Resolver	Encoder
23	BSM5NN-1	4.0 (101.7)	5.07 (128.7)	-	-	-
	BSM5NN-2	5.0 (127.1)	6.07 (154.1)	-	-	-
	BSM5NN-3	6.0 (152.5)	7.07 (179.5)	-	-	-
34	BSM6NN-1	4.56 (115.8)	5.33 (135.5)	-	-	-
	BSM6NN-2	5.56 (141.2)	5.96 (151.3)	-	-	-
	BSM6NN-3	6.56 (166.6)	6.96 (176.7)	-	-	-
42	BSM8NN-1	5.96 (151.3)	5.96 (151.3)	BSM8NC-1	5.67 (144.0)	5.69 (144.6)
	BSM8NN-2	7.21(183.0)	7.21 (183.0)	BSM8NC-2	6.67 (169.0)	6.69 (170.0)
	BSM8NN-3	8.46 (214.8)	8.46 (214.8)	BSM8NC-3	7.67 (194.8)	7.69 (195.4)
	-	-	-	BSM8NC-4	8.67 (220.2)	8.69 (220.8)
56	BSM9NN-1	6.99 (177.4)	6.99 (177.4)	BSM9NC-1	6.49 (164.7)	6.49 (164.7)
	BSM9NN-2	8.99 (228.2)	8.99 (228.2)	BSM9NC-2	7.99 (202.8)	7.99 (202.8)
	BSM9NN-3	10.99 (279.0)	10.99 (279.0)	BSM9NC-3	9.49 (240.9)	9.49 (240.9)
	BSM10NN-1	8.02 (203)	8.02 (203)	BSM10NC-1	6.49 (164.7)	6.49 (164.7)
	BSM10NN-2	10.0 (253.9)	10.0 (253.9)	BSM10NC-2	7.99 (202.8)	7.99 (202.8)
	BSM10NN-3	12.0 (304.7)	12.0 (304.7)	BSM10NC-3	9.49 (240.9)	9.49 (240.9)
	BSM10NN-4	14.0 (355.5)	14.0 (355.5)	BSM10NC-4	10.99 (279.0)	10.99 (279.0)
	-	-	-	BSM10NC-5	12.49 (317.1)	12.49 (317.1)
-	-	-	BSM10NC-6	13.99 (355.2)	13.99 (355.2)	

Note: Standard configuration: All motors are supplied with feedback device, NEMA mounting.

BSM 50/63/80 has two (2) threaded connectors for resolver and motor terminations.

BSM90/100 has one (1) threaded connector for resolver, termination of motor lead wires on terminal block.

Order mating cable assemblies/connectors as separate items.

Dimensions are for reference only. Detailed engineering drawings are available upon request.

Contact Baldor for dimension with other feedback devices and configurations.

Motor identification/optional specifying information MUST include the code of "N" designating NEMA dimensions, i.e. "BSM8NN-XXX".

Contact Baldor for other shaft dimensions.

## BSM Series - Blower cooling option

44

### BSM90/100 Series

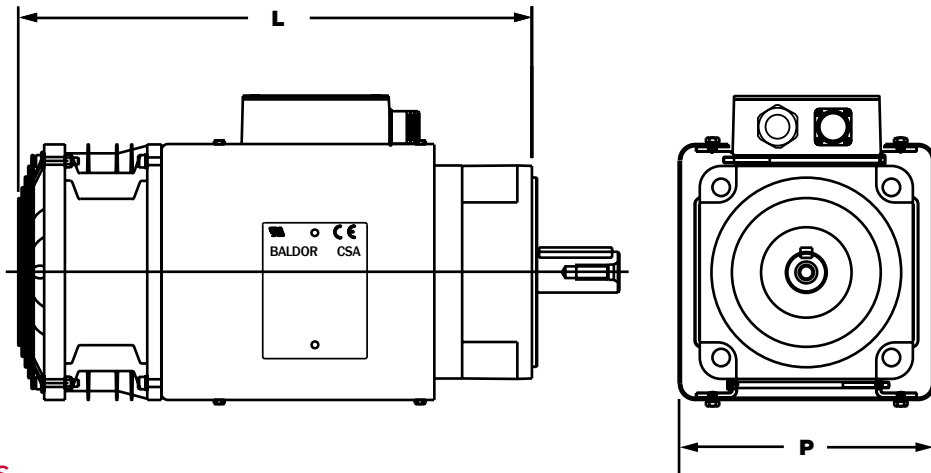

### BSM132 Series

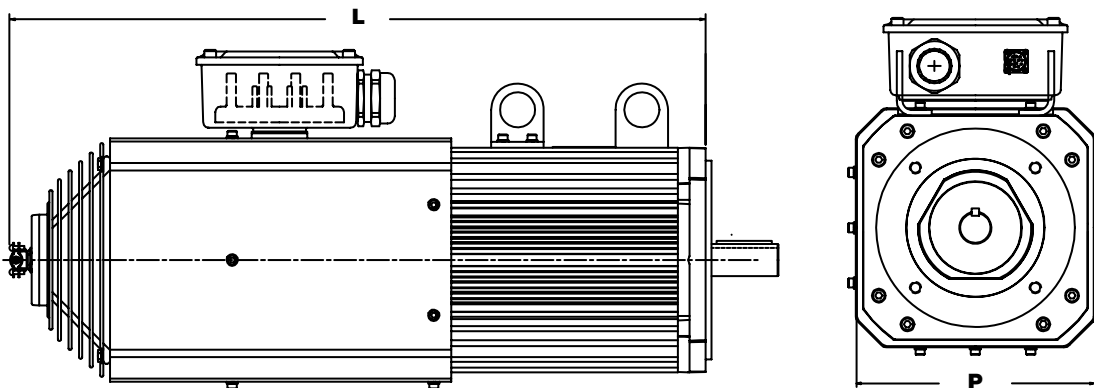

Dimensions  
N & C

## Blower Volt/Amp

Motor	Voltage	Amps	CFM
BSM90/100	115 vac 1ø 50/60 Hz	0.53	280/330
	230 vac 1ø 50/60 Hz	0.26	
	24 vdc	0.97	330
BSM132	230 vac 1ø 50/60 Hz	0.84	425/480
	460 vac 1ø 50/60 Hz	0.42	

Note: Dimensions are for reference only. Configuration shown is for resolver feedback.  
Detailed engineering drawings available upon request. Order blower separately

## Blower Kits for use with BSM90/100/132 motors

Motor code		Blower Kit Number			P dimension		L dimension											
		115 vac 1Ø	230 vac 1Ø	24 vdc	mm	inch	mm	inch										
BSM90N-2	Motor	BSM90N-2FN-1	BSM90N-2FN-8	BSM90N-2FN-D	175.5	6.91	381.8	15.03										
	Motor-Brake	BSM90N-2FNB-1	BSM90N-2FNB-8	BSM90N-2FNB-D			442.5	17.42										
BSM90N-3	Motor	BSM90N-3FN-1	BSM90N-3FN-8	BSM90N-3FN-D			175.5	6.91	432.6	17.03								
	Motor-Brake	BSM90N-3FNB-1	BSM90N-3FNB-8	BSM90N-3FNB-D					493.3	19.42								
BSM100N-3	Motor	BSM100N-3FN-1	BSM100N-3FN-8	BSM100N-3FN-D					175.5	6.91	453.5	17.85						
	Motor-Brake	BSM100N-3FNB-1	BSM100N-3FNB-8	BSM100N-3FNB-D							475.3	18.71						
BSM100N-4	Motor	BSM100N-4FN-1	BSM100N-4FN-8	BSM100N-4FN-D	175.5	6.91					504.3	19.85						
	Motor-Brake	BSM100N-4FNB-1	BSM100N-4FNB-8	BSM100N-4FNB-D							526.1	20.71						
BSM90C-2	Motor	BSM90C-2FN-1	BSM90C-2FN-8	BSM90C-2FN-D							175.5	6.91	356.4	14.03				
	Motor-Brake	BSM90C-2FNB-1	BSM90C-2FNB-8	BSM90C-2FNB-D									417.1	16.42				
BSM90C-3	Motor	BSM90C-3FN-1	BSM90C-3FN-8	BSM90C-3FN-D									175.5	6.91	394.5	15.53		
	Motor-Brake	BSM90C-3FNB-1	BSM90C-3FNB-8	BSM90C-3FNB-D											455.2	17.92		
BSM100C-3	Motor	BSM100C-3FN-1	BSM100C-3FN-8	BSM100C-3FN-D											175.5	6.91	391.1	15.4
	Motor-Brake	BSM100C-3FNB-1	BSM100C-3FNB-8	BSM100C-3FNB-D													437.8	17.24
BSM100C-4	Motor	BSM100C-4FN-1	BSM100C-4FN-8	BSM100C-4FN-D			175.5	6.91			429.2	16.9						
	Motor-Brake	BSM100C-4FNB-1	BSM100C-4FNB-8	BSM100C-4FNB-D							475.9	18.74						
BSM100C-5	Motor	BSM100C-5FN-1	BSM100C-5FN-8	BSM100C-5FN-D					175.5	6.91	467.3	18.4						
	Motor-Brake	BSM100C-5FNB-1	BSM100C-5FNB-8	BSM100C-5FNB-D							514	20.24						
BSM100C-6	Motor	BSM100C-6FN-1	BSM100C-6FN-8	BSM100C-6FN-D	175.5	6.91					505.4	19.9						
	Motor-Brake	BSM100C-6FNB-1	BSM100C-6FNB-8	BSM100C-6FNB-D							590.2	23.24						

Motor code		Blower Kit Number	P dimension		L dimension													
		230/460 vac 3Ø	mm	inch	mm	inch												
BSM132C-3	Motor	BSM132C-3FN-7	260.1	10.24	587.2	23.12												
	Motor-Brake	BSM132C-3FNB-7			680.2	26.78												
BSM132C-4	Motor	BSM132C-4FN-7			260.1	10.24	612.6	24.12										
	Motor-Brake	BSM132C-4FNB-7					705.6	27.78										
BSM132C-5	Motor	BSM132C-5FN-7					260.1	10.24	638.0	25.12								
	Motor-Brake	BSM132C-5FNB-7							731.0	28.78								
BSM132C-6	Motor	BSM132C-6FN-7							260.1	10.24	663.4	26.12						
	Motor-Brake	BSM132C-6FNB-7									756.4	29.78						
BSM132C-7	Motor	BSM132C-7FN-7									260.1	10.24	688.8	27.12				
	Motor-Brake	BSM132C-7FNB-7											781.8	30.78				
BSM132C-8	Motor	BSM132C-8FN-7											260.1	10.24	714.2	28.12		
	Motor-Brake	BSM132C-8FNB-7													807.2	31.78		
BSM132C-9	Motor	BSM132C-9FN-7													260.1	10.24	739.6	29.12
	Motor-Brake	BSM132C-9FNB-7															832.6	32.78

# Stainless Steel Brushless Servo

Baldor's totally stainless steel SSBSM series of motors are designed for food, liquid, washdown, hygiene and harsh, corrosive environments. These motors are designed to handle IP67 and withstand 1500 psi (103 bar) washdown conditions. Offered in standard and low inertia designs for best machine inertial matching. Included in this quality design are Teflon stainless steel double-sealed bearings with Viton O-rings, environmental protected stator with premium moisture resistant wire, and internal thermal over temperature protection. Baldor's SSBSM products are designed to be durable - they are BISSC, UL, cUL and CE approved.

### Torque Range Low Inertia Models

- › SSBSM50 3.9-12 lb-in (0.45-1.3 Nm)
- › SSBSM63 13-18.5 lb-in (1.4-2 Nm)
- › SSBSM80 23-32 lb-in (2.5-3.6 Nm)
- › SSBSM90 42-94 lb-in (4.8-10 Nm)
- › SSBSM100 163-283 lb-in (18-32 Nm)

### Torque Range Standard Inertia Models

- › SSBSM80 8-30 lb-in (0.9-3.4 Nm)
- › SSBSM90 37-55 lb-in (4.2-6.2 Nm)
- › SSBSM100 71-212 lb-in (8-24 Nm)



SSBSM

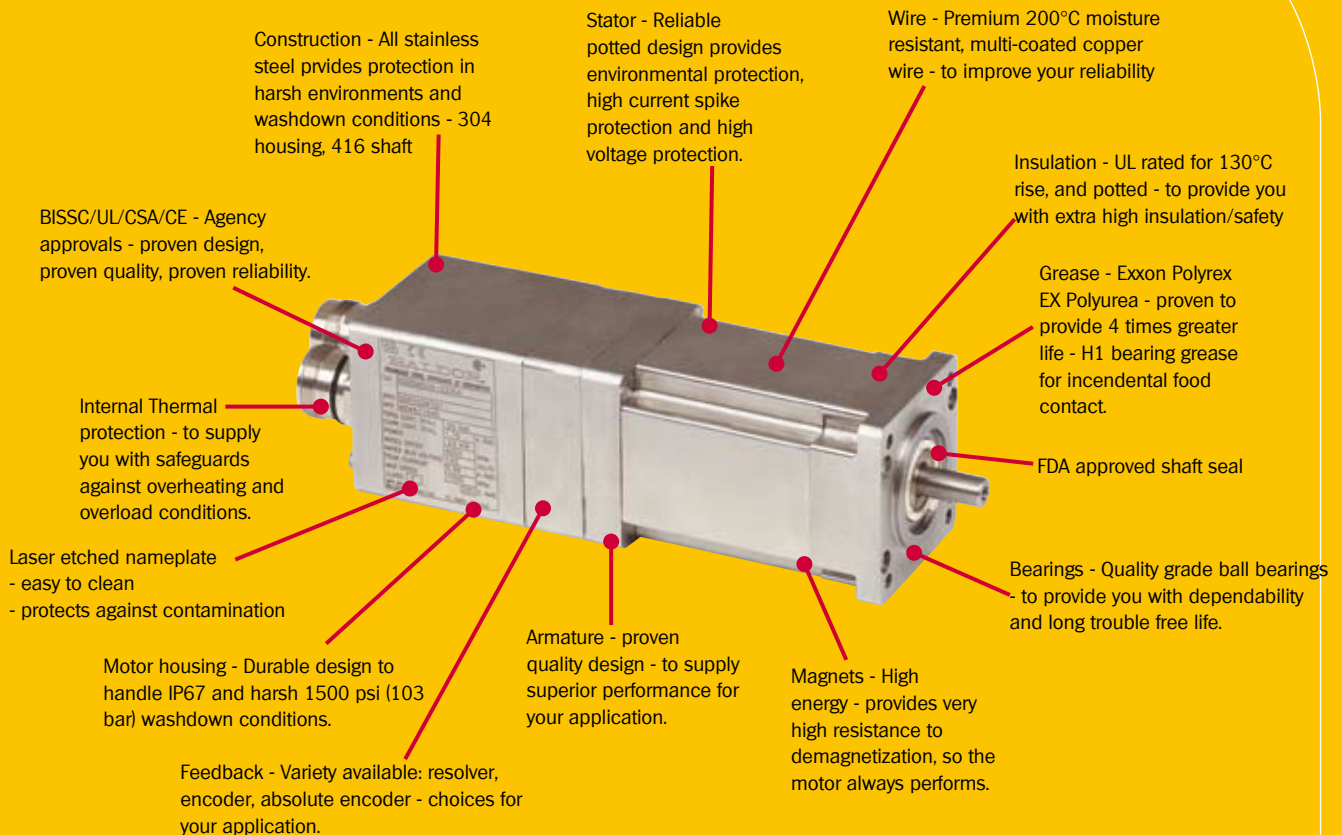

Stock and custom designs available.

Optional holding brakes. available.

Typical BSM63/80 Series shown.



## SSBSM-Series

Baldor's totally stainless steel SSBSM series of motors are designed for food, liquid, hygiene or corrosive environments. These motors are designed to handle IP67 applications and withstand 1500 psi washdown conditions. Included in this quality design are double sealed bearings and O-rings, environmental protected stator design with premium moisture resistant wire, and internal thermal over temperature protection. Baldor's SSBSM products are designed to be durable - they are BISSC, UL, cUL and CE approved.

## › Stainless Steel Brushless Servo Motors

Continuous Stall Torque		Continuous Stall Amps	Speed RPM @ 320V	Motor Catalog Number	Motor Inertia	
Lb-In	Nm				Lb-In-S <sup>2</sup>	Kg-cm <sup>2</sup>
Standard Inertia Stainless Steel Brushless Servo Motors - SSBSM C-Series						
8	0.9	1.5	4000	SSBSM80C-175CX	0.0016	1.81
17	1.9	2.6	4000	SSBSM80C-275CX	0.0033	3.73
25	2.8	5	4000	SSBSM80C-375CX	0.0049	5.61
30	3.4	5	4000	SSBSM80C-475CX	0.0066	7.45
37	4.2	3.5	2000	SSBSM90C-2150CX	0.0078	8.81
55	6.2	4.8	2000	SSBSM90C-3150CX	0.0117	13.2
71	8	6.4	2400	SSBSM100C-2150CX	0.0299	33.7
100	11.3	9.1	2400	SSBSM100C-3150CX	0.0448	50.6
142	16	13.4	2400	SSBSM100C-4150CX	0.0589	67.5
177	20	16.8	2000	SSBSM100C-5150CX	0.0747	84.4
212	24	19.2	2000	SSBSM100C-6150CX	0.0897	101.2
Low Inertia Stainless Steel Brushless Servo Motors - SSBSM N-Series						
3.9	0.45	0.8	4000	SSBSM50N-175CX	0.00006	0.0677
7.9	0.9	1.4	4000	SSBSM50N-275CX	0.00011	0.124
12	1.3	2.4	4000	SSBSM50N-375CX	0.00016	0.18
13	1.4	2.1	4000	SSBSM63N-275CX	0.00034	0.384
18.5	2.0	3.0	4000	SSBSM63N-375CX	0.00050	0.564
23	2.5	3.1	4000	SSBSM80N-275CX	0.00162	1.82
32	3.6	4.4	4000	SSBSM80N-375CX	0.00223	2.51
42	4.8	3.3	2000	SSBSM90N-1150CX	0.0030	3.38
70	7.9	5	2000	SSBSM90N-2150CX	0.0056	6.37
94	10	7.1	2000	SSBSM90N-3150CX	0.0082	9.26
163	18	13.4	2000	SSBSM100N-2150CX	0.0196	22.14
240	27	18.3	2000	SSBSM100N-3150CX	0.0273	30.8
283	32	14.4	1200	SSBSM100N-4250CX	0.0394	39.4

NOTE: ① Nominal rpm shown at 320 VDC bus for convenience. For 640 VDC double the speed. Reference motor table to verify that max speed is not exceeded. ② Stainless steel connectors rated for 20 amps. ③ For X callout, see motor ID matrix.

# SSBSM Stainless Series Performance Curves

48

## SSBSM80C-175

## SSBSM80C-275

## SSBSM80C-375

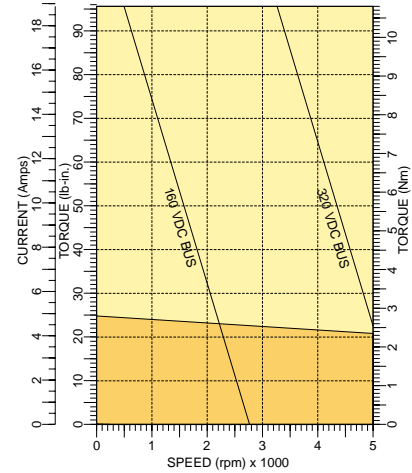
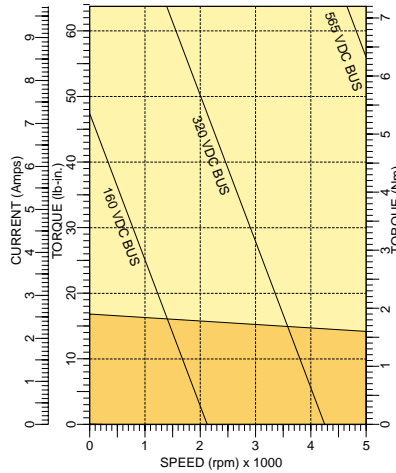
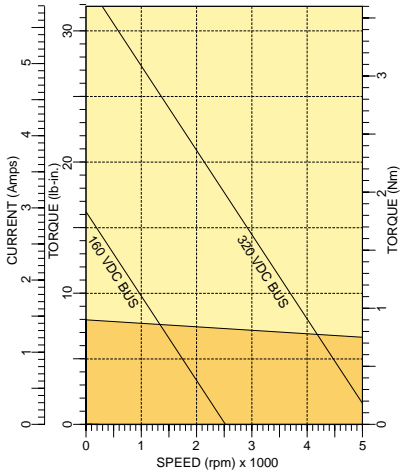

SSBSM

Model Number		SSBSM80C-175	SSBSM80C-275	SSBSM80C-375
<b>General</b>				
Continuous Stall Torque	lb-in	8.0	16.8	24.8
	N-m	0.9	1.9	2.8
Continuous Current	amps	1.5	2.6	5.0
Peak Torque	lb-in	23.9	50.4	74.3
	N-m	2.7	5.7	8.4
Peak Current	amps	3.9	6.6	13.9
Thermal Resistance	°C/watt	2.08	1.78	1.58
Thermal Time Constant	Min	19	23	28
Mechanical Time Constant	msec	5.96	3.54	2.7
Electrical Time Constant	msec	1.65	2.63	3.73
Rated Speed @ 300 volts	rpm	4000	4000	4000
Rated Speed @ 600 volts	rpm	8000	8000	8000
<b>Electrical</b>				
Torque Constant	lb-in/amp	6.5	7.7	6.0
	N-m/amp	0.73	0.87	0.67
Voltage Constant	Vpk/krpm	62.5	74.5	57.5
	Vrms/krpm	44.2	52.7	40.7
Resistance	ohms	17.6	7.2	2.2
Inductance	mH	29.1	18.9	8.2
<b>Mechanical</b>				
Inertia	lb-in-s <sup>2</sup>	0.0016	0.0033	0.0049
	Kg-cm <sup>2</sup>	1.81	3.73	5.53
Maximum Speed	rpm	10,000	10,000	10,000
Number of Motor Poles		4	4	4
Weight	lbs/Kg	12/5.5	15/6.8	18/8.2



# SSBSM Stainless Series Performance Curves

SSBSM80C-475

SSBSM90C-2150

SSBSM90C-3150

49

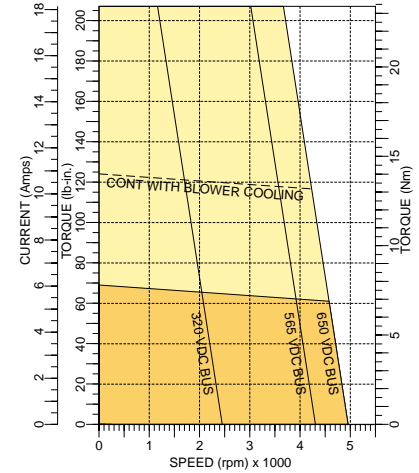
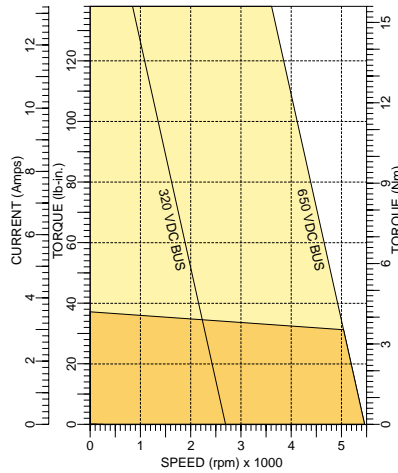
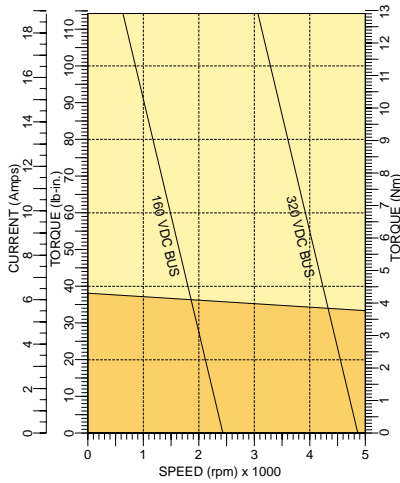

Model Number		SSBSM80C-475	SSBSM90C-2150	SSBSM90C-3150
<b>General</b>				
Continuous Stall Torque	lb-in	30.1	37.2	54.9
	N-m	3.4	4.2	6.2
Continuous Current	amps	5.3	3.5	4.8
Peak Torque	lb-in	90.3	111.5	164.6
	N-m	10.2	12.6	18.6
Peak Current	amps	13.6	10.1	12.3
Thermal Resistance	°C/watt	1.82	1.41	1.39
Thermal Time Constant	Min	32	45	55
Mechanical Time Constant	msec	2.42	2.32	1.55
Electrical Time Constant	msec	3.16	2.96	4.22
Rated Speed @ 300 volts	rpm	4000	2000	2000
Rated Speed @ 600 volts	rpm	8000	4000	4000
<b>Electrical</b>				
Torque Constant	lb-in/amp	6.7	12.2	13.4
	N-m/amp	0.76	1.38	1.52
Voltage Constant	Vpk/krpm	65.2	118.8	129.8
	Vrms/krpm	46.0	84	91.8
Resistance	ohms	1.9	5	2.7
Inductance	mH	6.2	14.8	11.4
<b>Mechanical</b>				
Inertia	lb-in-s <sup>2</sup>	0.0066	0.0078	0.0117
	Kg-cm <sup>2</sup>	7.45	8.81	13.21
Maximum Speed	rpm	10,000	7000	7000
Number of Motor Poles		4	8	8
Weight	lbs/Kg	21/9.5	34/15.5	39.5/17.9

SSBSM

# SSBSM Stainless Series Performance Curves

50

## SSBSM100C-2150

## SSBSM100C-3150

## SSBSM100C-4150

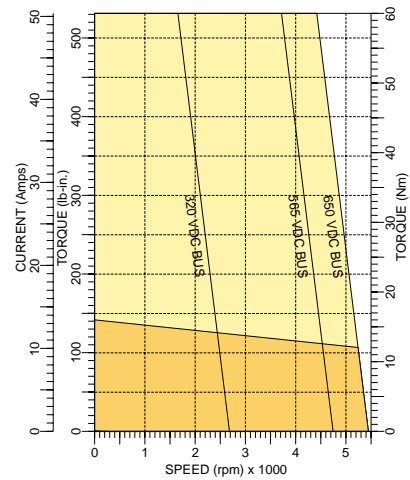
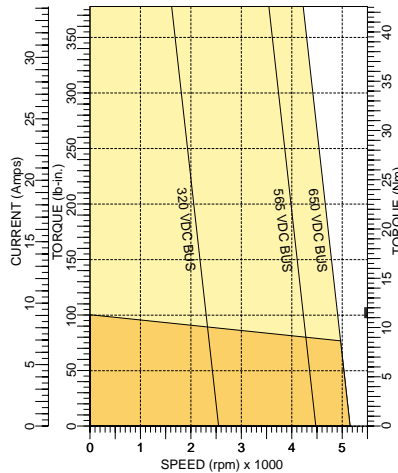
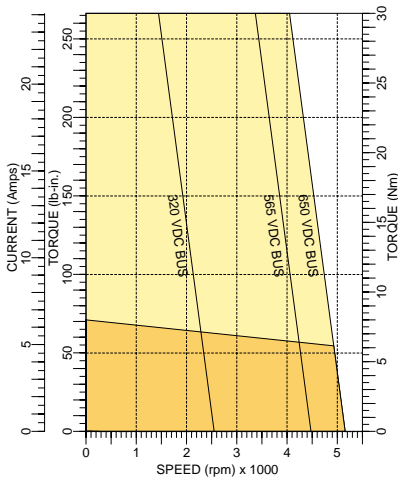

SSBSM

Model Number		SSBSM100C-2150	SSBSM100C-3150	SSBSM100C-4150
<b>General</b>				
Continuous Stall Torque	lb-in	70.8	100	141.6
	N-m	8	11.3	16
Continuous Current	amps	6.4	9.1	13.4
Peak Torque	lb-in	212.4	300	424.8
	N-m	24.0	33.9	48.0
Peak Current	amps	18.3	23.2	38.4
Thermal Resistance	°C/watt	1.32	1.28	0.85
Thermal Time Constant	Min	54	62	70
Mechanical Time Constant	msec	2.54	2.00	2.00
Electrical Time Constant	msec	5.13	7.62	7.54
Rated Speed @ 300 volts	rpm	2400	2400	2400
Rated Speed @ 600 volts	rpm	4800	4800	4800
<b>Electrical</b>				
Torque Constant	lb-in/amp	12.9	12.9	12.3
	N-m/amp	1.46	1.46	1.39
Voltage Constant	Vpk/krpm	125.0	125.0	118.9
	Vrms/krpm	88.4	88.4	84.1
Resistance	ohms	1.6	0.82	0.57
Inductance	mH	8.2	6.4	4.3
<b>Mechanical</b>				
Inertia	lb-in-s <sup>2</sup>	0.0299	0.0448	0.0598
	Kg-cm <sup>2</sup>	33.77	50.66	67.54
Maximum Speed	rpm	7000	7000	7000
Number of Motor Poles		8	8	8
Weight	lbs/Kg	44.5/20.2	51.5/23.4	58.5/26.6

# SSBSM Stainless Series Performance Curves

## SSBSM100C-5150

## SSBSM100C-6150

## SSBSM50N-175

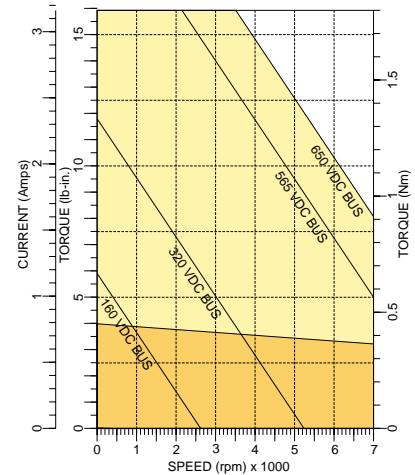
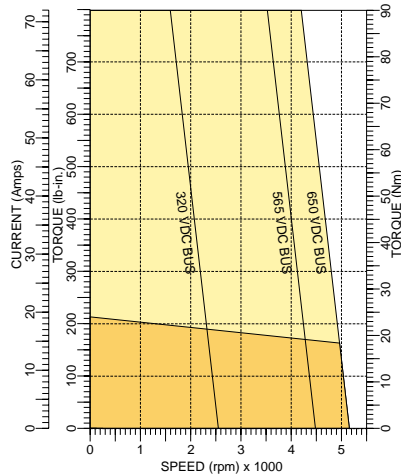
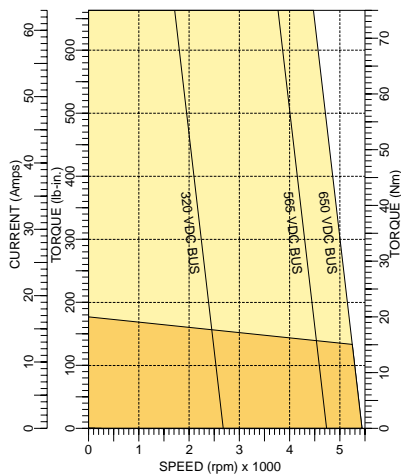

Model Number		SSBSM100C-5150	SSBSM100C-6150	SSBSM50N-175
<b>General</b>				
Continuous Stall Torque	lb-in	177.0	212.4	3.9
	N-m	20	24	0.45
Continuous Current	amps	16.8	19.2	0.79
Peak Torque	lb-in	531.0	637.2	15.9
	N-m	60.0	72.0	1.8
Peak Current	amps	48.0	54.8	2.5
Thermal Resistance	°C/watt	0.75	0.73	2.85
Thermal Time Constant	Min	77	85	7
Mechanical Time Constant	msec	1.80	2.15	0.6
Electrical Time Constant	msec	8.54	5.78	1.3
Rated Speed @ 300 volts	rpm	2000	2000	4000
Rated Speed @ 600 volts	rpm	4000	4000	2130
<b>Electrical</b>				
Torque Constant	lb-in/amp	12.3	12.9	6.31
	N-m/amp	1.39	1.46	0.71
Voltage Constant	Vpk/krpm	118.9	125	60.94
	Vrms/krpm	84.1	88.4	43.1
Resistance	ohms	0.41	0.37	47.5
Inductance	mH	3.5	3.2	63.5
<b>Mechanical</b>				
Inertia	lb-in-s <sup>2</sup>	0.0747	0.0897	0.00006
	Kg-cm <sup>2</sup>	84.43	101.27	0.0677
Maximum Speed	rpm	7000	7000	10,000
Number of Motor Poles		8	8	4
Weight	lbs/Kg	65.5/29.7	72.5/32.9	5/2.3

# SSBSM Stainless Series Performance Curves

52

SSBSM50N-275

SSBSM50N-375

SSBSM63N-275

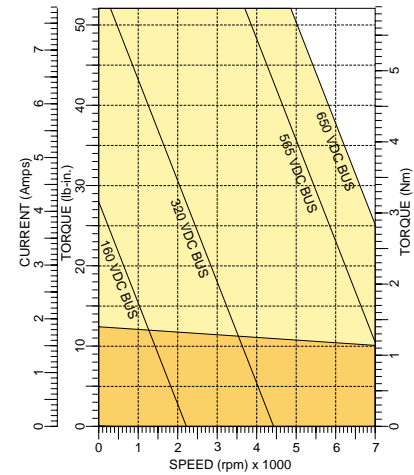
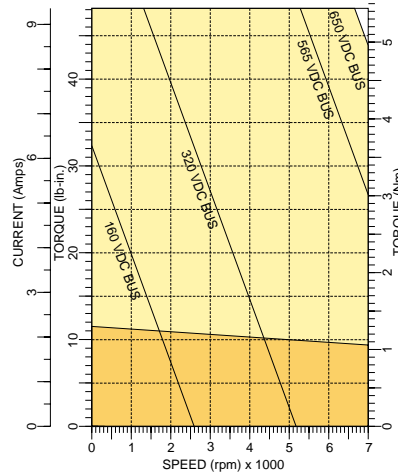
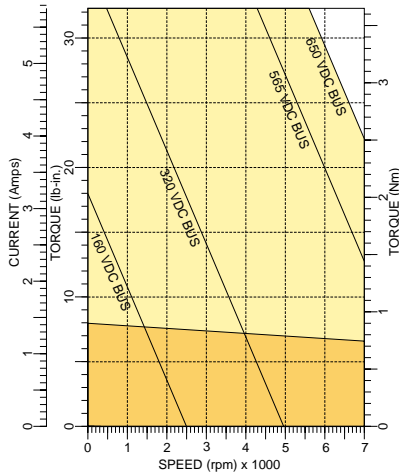

SSBSM

Model Number		SSBSM50N-275	SSBSM50N-375	SSBSM63N-275
<b>General</b>				
Continuous Stall Torque	lb-in	7.9	12	13
	N-m	0.9	1.3	1.4
Continuous Current	amps	1.4	2.4	1.9
Peak Torque	lb-in	32	48	52
	N-m	3.6	5.4	5.9
Peak Current	amps	4.8	8	6.9
Thermal Resistance	°C/watt	2.76	1.77	2.08
Thermal Time Constant	Min	11	15	19
Mechanical Time Constant	msec	0.35	0.29	0.62
Electrical Time Constant	msec	2.1	1.8	2.1
Rated Speed @ 300 volts	rpm	3750	4000	4000
Rated Speed @ 160 volts	rpm	2000	2130	2130
<b>Electrical</b>				
Torque Constant	lb-in/amp	6.6	6.4	7.47
	N-m/amp	0.75	0.72	0.84
Voltage Constant	Vpk/krpm	64.34	61.9	72.1
	Vrms/krpm	45.5	43.8	51
Resistance	ohms	16	8.5	11.6
Inductance	mH	33.2	16	24.7
<b>Mechanical</b>				
Inertia	lb-in-s <sup>2</sup>	0.00011	0.00016	0.00034
	Kg-cm <sup>2</sup>	0.124	0.18	0.384
Maximum Speed	rpm	10,000	10,000	10,000
Number of Motor Poles		4	4	4
Weight	lbs/Kg	5.75/2.6	6.5/2.9	8/3.6

# SSBSM Stainless Series Performance Curves

## SSBSM63N-375

## SSBSM80N-275

## SSBSM80N-375

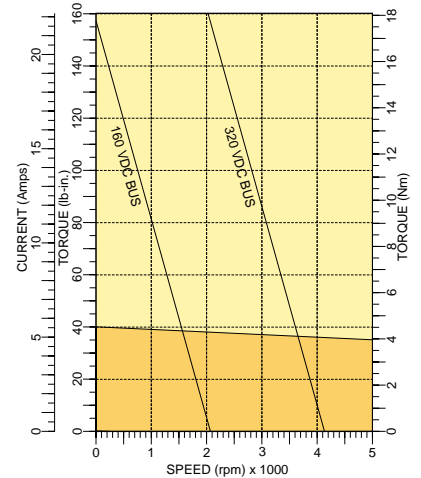
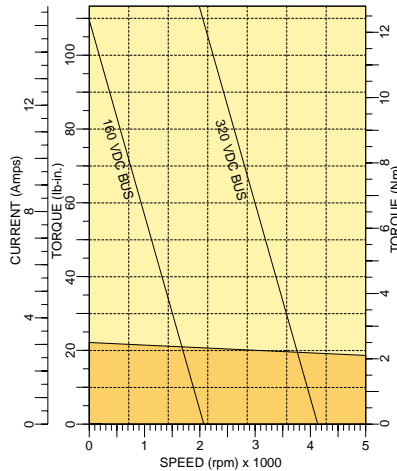
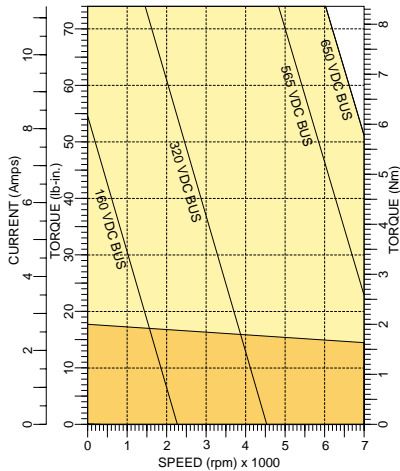

Model Number		SSBSM63N-375	SSBSM80N-275	SSBSM80N-375
<b>General</b>				
Continuous Stall Torque	lb-in	18.5	23	32
	N-m	2	2.5	3.6
Continuous Current	amps	2.8	3.1	4.4
Peak Torque	lb-in	74	92	128
	N-m	8.4	10.4	14.5
Peak Current	amps	10	11.2	15.9
Thermal Resistance	°C/watt	1.87	2.82	2.02
Thermal Time Constant	Min	23	28	34
Mechanical Time Constant	msec	0.5	0.72	0.69
Electrical Time Constant	msec	2.3	3.9	4.2
Rated Speed @ 300 volts	rpm	4000	4000	4000
Rated Speed @ 160 volts	rpm	2130	2130	2130
<b>Electrical</b>				
Torque Constant	lb-in/amp	7.2	8	8
	N-m/amp	0.82	0.9	0.9
Voltage Constant	Vpk/krpm	70.2	77.3	77.4
	Vrms/krpm	49.7	54.7	54.7
Resistance	ohms	5.92	3.2	2.22
Inductance	mH	13.65	12.73	9.3
<b>Mechanical</b>				
Inertia	lb-in-s <sup>2</sup>	0.0005	0.00162	0.00223
	Kg-cm <sup>2</sup>	0.564	1.82	2.51
Maximum Speed	rpm	10,000	7000	7000
Number of Motor Poles		4	4	4
Weight	lbs/Kg	9/4	15.5/7	18.5/8.4

# SSBSM Stainless Series Performance Curves

54

## SSBSM90N-1150

## SSBSM90N-2150

## SSBSM90N-3150

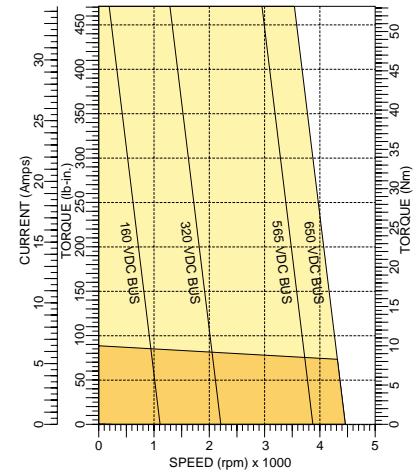
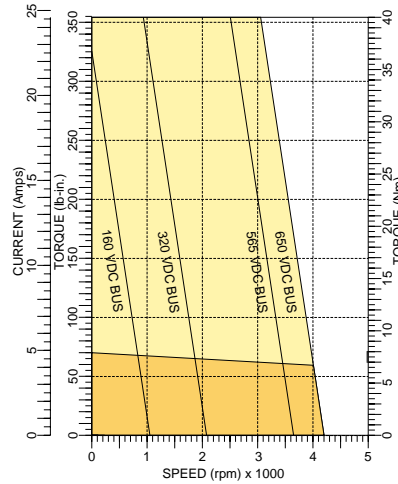
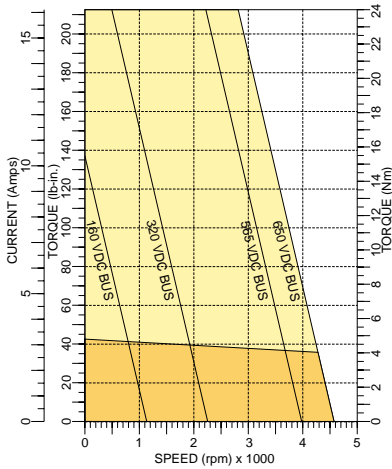

SSBSM

Model Number		SSBSM90N-1150	SSBSM90N-2150	SSBSM90N-3150
<b>General</b>				
Continuous Stall Torque	lb-in	42	70	94
	N-m	4.8	7.9	10
Continuous Current	amps	3.3	5	7.1
Peak Torque	lb-in	168	280	376
	N-m	19.0	31.6	42.5
Peak Current	amps	12	17.6	24.8
Thermal Resistance	°C/watt	1.84	1.81	1.69
Thermal Time Constant	Min	38	49	59
Mechanical Time Constant	msec	0.54	0.38	0.33
Electrical Time Constant	msec	4.06	5.4	5.4
Rated Speed @ 300 volts	rpm	2000	2000	2000
Rated Speed @ 600 volts	rpm	4000	4000	4000
<b>Electrical</b>				
Torque Constant	lb-in/amp	14.1	15.9	15
	N-m/amp	1.65	1.8	1.7
Voltage Constant	Vpk/krpm	141.33	154.55	146.07
	Vrms/krpm	99.95	109.3	103.3
Resistance	ohms	4.33	1.92	1.02
Inductance	mH	17.6	10.5	5.53
<b>Mechanical</b>				
Inertia	lb-in-s <sup>2</sup>	0.003	0.0056	0.0082
	Kg-cm <sup>2</sup>	3.38	6.32	9.25
Maximum Speed	rpm	7000	7000	7000
Number of Motor Poles		8	8	8
Weight	lbs/Kg	23.5/10.7	25.5/11.6	27.5/12.5

# SSBSM Stainless Series Performance Curves

SSBSM100N-2150

SSBSM100N-3150

SSBSM100N-4250

55

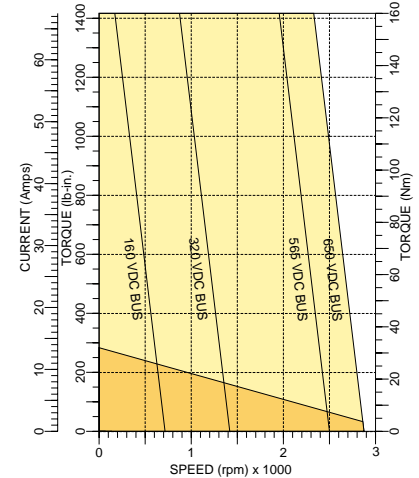
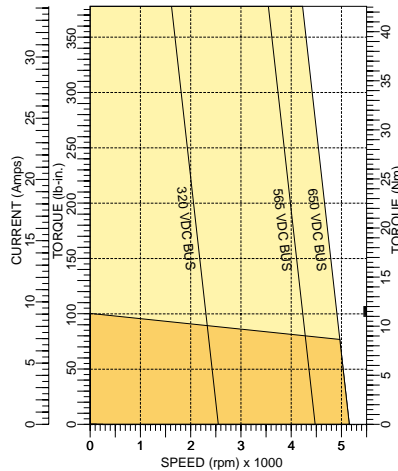
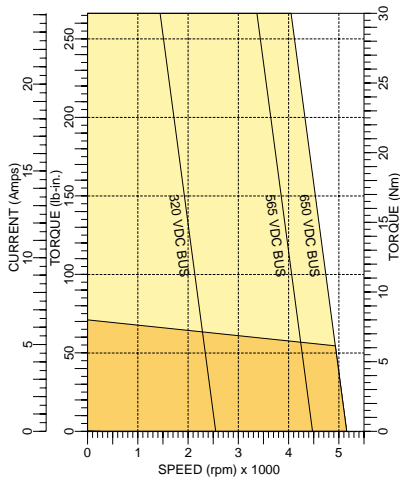

Model Number		SSBSM100N-2150	SSBSM100N-3150	SSBSM100N-4250
<b>General</b>				
Continuous Stall Torque	lb-in	163	240	283
	N-m	18	27	32
Continuous Current	amps	12.4	16.8	13.4
Peak Torque	lb-in	652	960	1132
	N-m	73.7	108.5	127.9
Peak Current	amps	44.6	60.6	48.5
Thermal Resistance	°C/watt	1.41	1.23	1.05
Thermal Time Constant	Min	67	76	85
Mechanical Time Constant	msec	0.33	0.24	0.26
Electrical Time Constant	msec	8.3	10.9	10.5
Rated Speed @ 300 volts	rpm	2000	2000	1200
Rated Speed @ 600 volts	rpm	4000	4000	4000
<b>Electrical</b>				
Torque Constant	lb-in/amp	14.5	15.8	23.2
	N-m/amp	1.6	1.79	2.63
Voltage Constant	Vpk/krpm	140.8	153.2	225.1
	Vrms/krpm	99.6	108.3	159.2
Resistance	ohms	0.4	0.25	0.46
Inductance	mH	3.33	2.74	4.86
<b>Mechanical</b>				
Inertia	lb-in-s <sup>2</sup>	0.0196	0.0273	0.0349
	Kg-cm <sup>2</sup>	22.12	30.82	39.40
Maximum Speed	rpm	4000	4000	4000
Number of Motor Poles		8	8	8
Weight	lbs/Kg	59/26.8	71.32.2	83/37.7

SSBSM



# Stainless Steel Brushless Servo Motors

## SSBSM Series Dimensions - IEC Mountings

### SSBSM50/63/80 Series

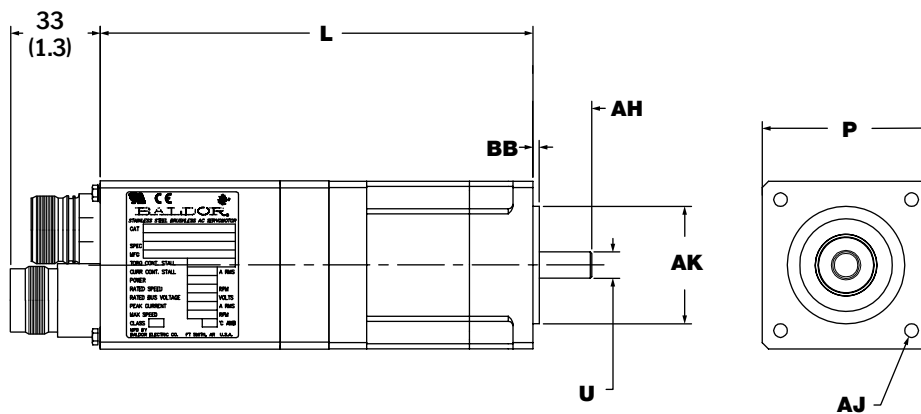

### SSBSM90/100 Series

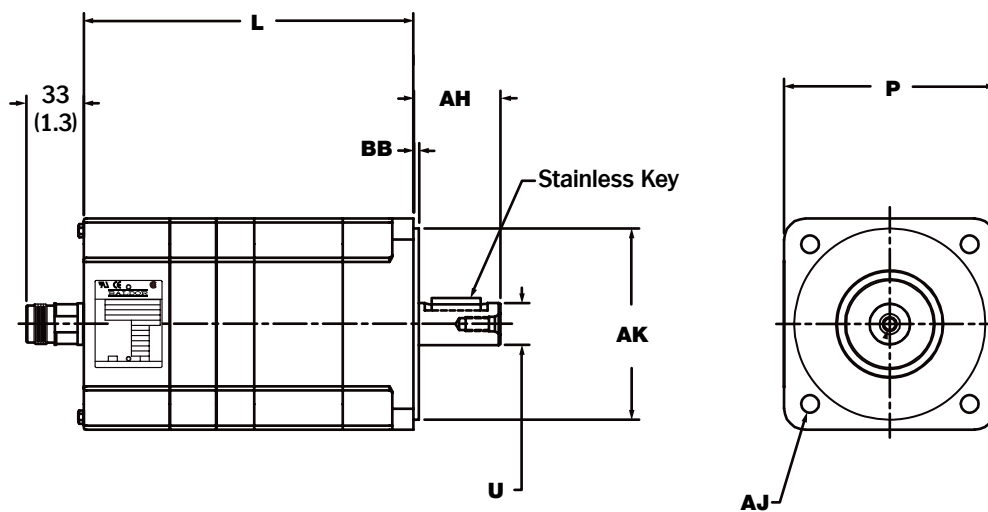

# BSM Series Dimensions - IEC Mountings continued...

Dimensions in mm (inch)

Motor Code	P	U	AH	Key	AJ	AK	BB
SSBSM50N	57 (2.25)	9 (0.35)	20 (0.78)	NONE	4.5 mm thru hole 63 mm B.C.	40 (1.5)	2.5 (0.098)
SSBSM63N	69 (2.72)	11 (0.43)	23 (0.9)	4x4x12	5.8 mm thru hole 75 mm B.C.	60 (2.3)	2.5 (0.098)
SSBSM80C/N	91.3 (3.59)	19 (0.74)	40 (1.5)	6x6x25	7.0 mm thru hole 100 mm B.C.	80 (3.1)	3.0 (0.118)
SSBSM90C/N	121.7 (4.79)	24 (0.94)	50 (2.0)	8x7x36	10 mm thru hole 130 mm B.C.	110 (4.3)	3.5 (0.138)
SSBSM100C/N	148 (5.83)	28 (1.1)	60 (2.3)	8x7x36	12 mm thru hole 165 mm B.C.	130 (5.1)	3.5 (0.138)

Motor Code	Length - L		Motor Code	Length - L	
	Resolver	Encoder		Resolver	Encoder
SSBSM50N-1	147.4 (5.80)	147.4 (5.80)	SSBSM80C-1	156.2 (6.15)	156.2 (6.15)
SSBSM50N-2	172.8 (6.80)	172.8 (6.80)	SSBSM80C-2	181.6 (7.15)	181.6 (7.15)
SSBSM50N-3	198.2 (7.80)	198.2 (7.80)	SSBSM80C-3	207.0 (8.15)	207.0 (8.15)
SSBSM63N-2	180.9 (7.12)	180.9 (7.12)	SSBSM80C-4	232.4 (9.15)	232.4 (9.15)
SSBSM63N-3	206.3 (8.12)	206.3 (8.12)	SSBSM90C-2	227.7 (8.96)	227.7 (8.96)
SSBSM80N-2	194.3 (7.65)	194.3 (7.65)	SSBSM90C-3	265.8 (10.46)	265.8 (10.46)
SSBSM80N-3	226.1 (8.90)	226.1 (8.90)	SSBSM100C-2	230.1 (9.06)	230.1 (9.06)
SSBSM90N-1	202.3 (7.96)	202.3 (7.96)	SSBSM100C-3	268.2 (10.56)	268.2 (10.56)
SSBSM90N-2	253.1 (9.96)	253.1 (9.96)	SSBSM100C-4	306.3 (12.06)	306.3 (12.06)
SSBSM90N-3	303.9 (11.96)	303.9 (11.96)	SSBSM100C-5	344.4 (13.56)	344.4 (13.56)
SSBSM100N-2	280.9 (11.06)	280.9 (11.06)	SSBSM100C-6	382.5 (15.06)	382.5 (15.06)
SSBSM100N-3	331.7 (13.06)	331.7 (13.06)			
SSBSM100N-4	382.5 (15.06)	382.5 (15.06)			

Note: Standard configuration: All motors supplied with feedback device. Square mounting flange.

SSBSM 50/63/80 has two (2) threaded connectors for feedback and motor terminations.

Order mating cable assemblies/connectors as separate items.

The motors have a threaded hole on the shaft end. The SSBSM63 series is M4 x 0.7 threads (11mm deep). The SSBSM80 series is M6 x 1.0 threads (17 mm deep). The SSBSM90 series is M6 x 1.0 threads (17 mm deep). The SSBSM100 series is M10 x 1.5 threads (23 mm deep). Dimensions are for reference only and may change for other selected option. Detailed engineering drawings are available upon request.

Contact Baldor for dimensions with other feedback devices.

# Brushless Motors BSM 25 & 33 Series

The BSM 25 and 33 series provide a durable round housing design that has capability of foot mounting. Using Baldor's standard reliable Neodymium magnet design, many applications, especially adjustable speed applications, can now make use of brushless technology benefits – less maintenance, quieter operation, faster acceleration, higher torque and power output. Although introduced with Hall sensor feed back for adjustable speed applications, the BSM25 and BSM33 series are available to be fitted with a wide variety of feedback devices to suit demanding servo application needs.

## Torque Range

- › BSM25 1/4 - 1/2 HP – 18-23 lb-in (2-2.6 Nm)
- › BSM33 1/2 - 3 HP – 27 - 138 lb-in (3-15.6 Nm)

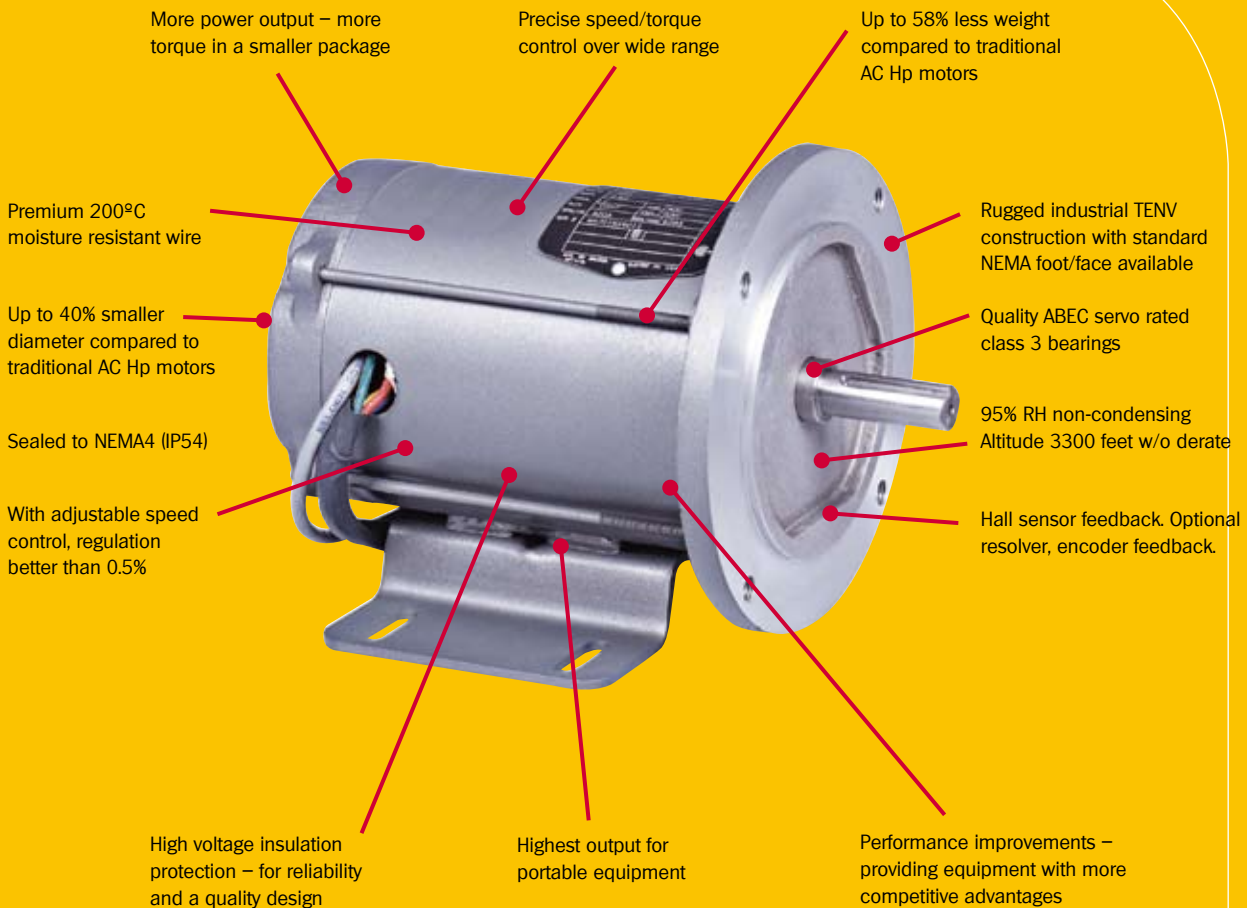

BSM25/33



## BSM 25 & 33 Series

The BSM 25/33 series allows many applications to make use of the advantages of brushless technology including higher torque in smaller packages, quieter operation and less maintenance. Continuous stall torque range from 18.6 lb-in (2Nm) to 138 lb-in (15.6 Nm) with available peak torques of 3 times. This series will increase productivity while providing reliability and durability to provide equipment with more competitive advantages in your market.

### Brushless Motors – BSM 25 & 33 Series

Continuous Stall Torque		Continuous Stall Amps	Speed RPM @ 320V ①	HP @ 1800 RPM	Motor Number ②	Motor Inertia	
Lb-In	Nm					Lb-In-S <sup>2</sup>	Kg - cm <sup>2</sup>
18.6	2.1	1.5	1400	1/4 HP	BSM25C-1177MHC	0.00241	2.72
23.0	2.6	1.90	1400	1/2 HP	BSM25C-2177MHC	0.0028	3.16
27.4	3.1	2.55	1800	1/2 HP	BSM33C-2177MHQ	0.00374	4.22
35.4	4	3.16	1800	1 HP	BSM33C-3177MHQ	0.00536	6.05
79.7	9	6.47	1800	1.5	BSM33C-4177MHQ	0.01033	11.66
99.1	11.2	9.15	2100	2 HP	BSM33C-5177MHQ	0.01212	13.68
138.1	15.6	14.23	2400	3 HP	BSM33C-6177MHQ	0.01859	20.99

NOTE: ① Nominal rpm shown at 320 VDC bus for convenience. For 640 VDC double the speed. Reference motor table to verify that max speed is not exceeded. ② Motors shown with these options for convenience: H = Hall Sensor, C = Round face only, Q = Fast & Round Face.

For other options see BSM25/33 ID matrix under engineering information.

# SSBSM Stainless Series Performance Curves

60

**BSM25C-1177MHC**

**BSM25C-2177MHC**

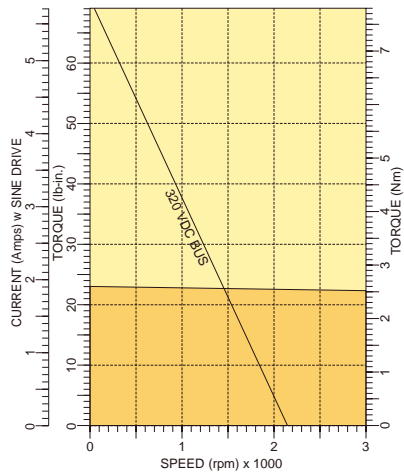
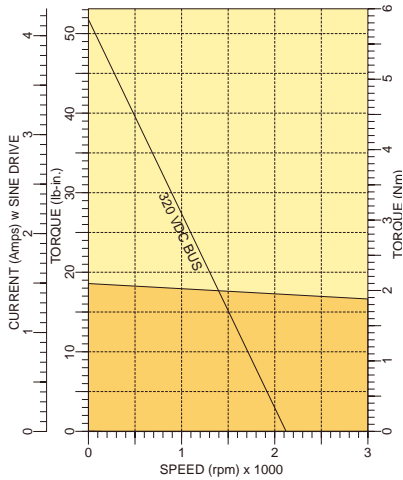

Model Number		BSM25C-1177MHC	BSM25C-2177MHC
<b>General</b>			
Continuous Stall Torque	lb-in	18.6	23.0
	N-m	2.1	2.6
Continuous Current (1)	amps	1.50	1.90
Peak Torque	lb-in	55.8	69.0
	N-m	6.3	7.8
Peak Current (1)	amps	4.5	5.7
Thermal Resistance	°C/watt	1.44	1.24
Thermal Time Constant	Min	24	26.2
Mechanical Time Constant	msec	2.38	2.10
Electrical Time Constant	msec	3.98	3.73
Rated Speed @ 300 volts	rpm	3500	3500
Rated Speed @ 600 volts	rpm	1400	1400
<b>Electrical</b>			
Torque Constant	lb-in/amp	15.5	15.1
	N-m/amp	1.75	1.71
Voltage Constant	Vpk/krpm	150.0	146.5
	Vrms/krpm	106.1	103.6
Resistance	ohms	26.7	19.4
Inductance	mH	106.3	72.3
<b>Mechanical</b>			
Inertia	lb-in-s <sup>2</sup>	0.00241	0.0028
	Kg-cm <sup>2</sup>	2.72	3.16
Maximum Speed	rpm	7000	7000
Number of Motor Poles		4	4
Weight	lbs/Kg	11.1/5.0	14.4/6.5

(1) With Sine Drive

# SSBSM Stainless Series Performance Curves

**BSM33C-2177MHQ**

**BSM33C-3177MHQ**

**BSM33C-4177MHQ**

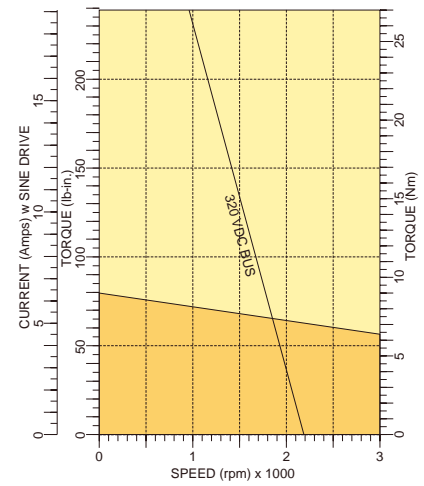
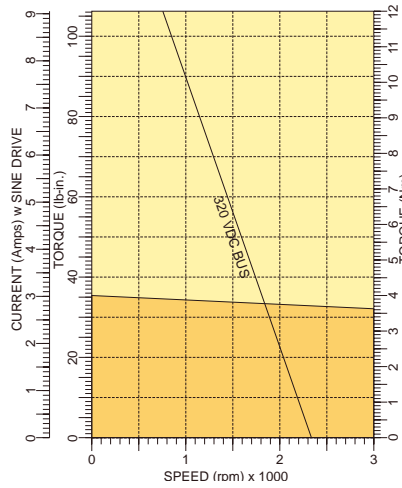
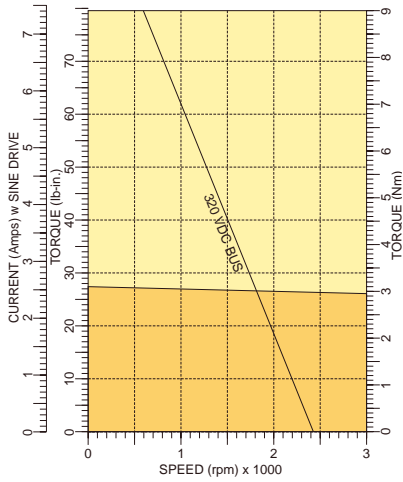

Model Number		BSM33C-2177MHQ	BSM33C-3177MHQ	BSM33C-4177MHQ
<b>General</b>				
Continuous Stall Torque	lb-in	27.4	35.4	79.7
	N-m	3.1	4	9
Continuous Current (1)	amps	2.55	3.16	6.47
Peak Torque	lb-in	82.3	106.2	239.0
	N-m	9.3	12	27
Peak Current (1)	amps	7.6	9.5	19.4
Thermal Resistance	°C/watt	1.17	1.10	0.69
Thermal Time Constant	Min	27.8	29.5	33.9
Mechanical Time Constant	msec	2.09	1.92	1.16
Electrical Time Constant	msec	3.81	4.37	5.75
Rated Speed @ 300 volts	rpm	3900	3900	3900
Rated Speed @ 600 volts	rpm	1800	1800	1800
<b>Electrical</b>				
Torque Constant	lb-in/amp	13.5	14.0	15.4
	N-m/amp	1.52	1.58	1.74
Voltage Constant	Vpk/krpm	130.3	135.4	149.1
	Vrms/krpm	92.1	95.8	105.5
Resistance	ohms	11.4	7.88	2.99
Inductance	mH	43.4	34.4	17.2
<b>Mechanical</b>				
Inertia	lb-in-s <sup>2</sup>	0.00374	0.00536	0.01033
	Kg-cm <sup>2</sup>	4.22	6.05	11.66
Maximum Speed	rpm	7000	7000	7000
Number of Motor Poles		8	8	8
Weight	lbs/Kg	14.9/6.8	17.3/7.9	25.3/11.5

(1) With Sine Drives

# SSBSM Stainless Series Performance Curves

62

**BSM33C-5177MHQ**

**BSM33C-6177MHQ**

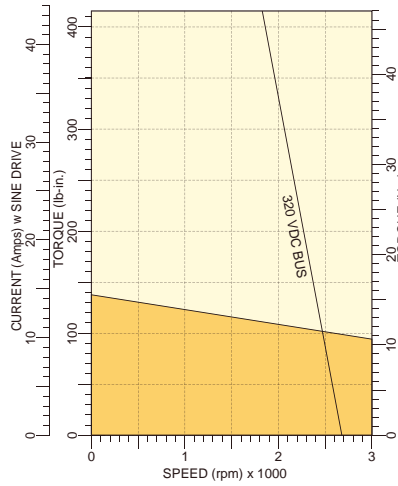
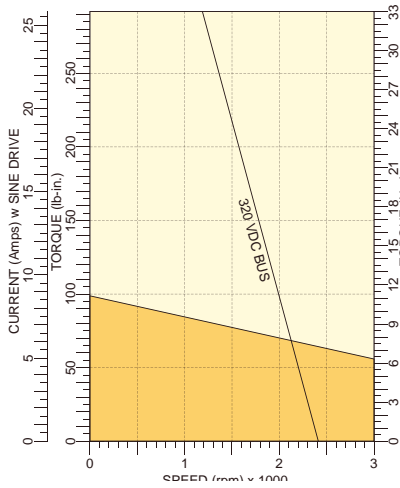

BSM25/33

Model Number		BSM33C-5177MHQ	BSM33C-6177MHQ
<b>General</b>			
Continuous Stall Torque	lb-in	99.1	138.1
	N-m	11.2	15.6
Continuous Current (1)	amps	9.15	14.23
Peak Torque	lb-in	297.4	414.2
	N-m	33.6	46.8
Peak Current (1)	amps	27.5	42.7
Thermal Resistance	°C/watt	0.52	0.52
Thermal Time Constant	Min	39.8	59.5
Mechanical Time Constant	msec	1.20	0.90
Electrical Time Constant	msec	5.83	6.80
Rated Speed @ 300 volts	rpm	4300	4600
Rated Speed @ 600 volts	rpm	2100	2400
<b>Electrical</b>			
Torque Constant	lb-in/amp	13.5	12.1
	N-m/amp	1.53	1.37
Voltage Constant	Vpk/krpm	131.1	117.4
	Vrms/krpm	92.7	83.0
Resistance	ohms	2.04	0.8
Inductance	mH	11.9	5.44
<b>Mechanical</b>			
Inertia	lb-in-s <sup>2</sup>	0.01212	0.01859
	Kg-cm <sup>2</sup>	13.68	20.99
Maximum Speed	rpm	7000	7000
Number of Motor Poles		8	8
Weight	lbs/Kg	30.4/13.8	40.2/18.3

(1) With Sine Drive



# Brushless Motors

## Dimensions - NEMA Mountings

Dimensions in inch

### BSM25 Series

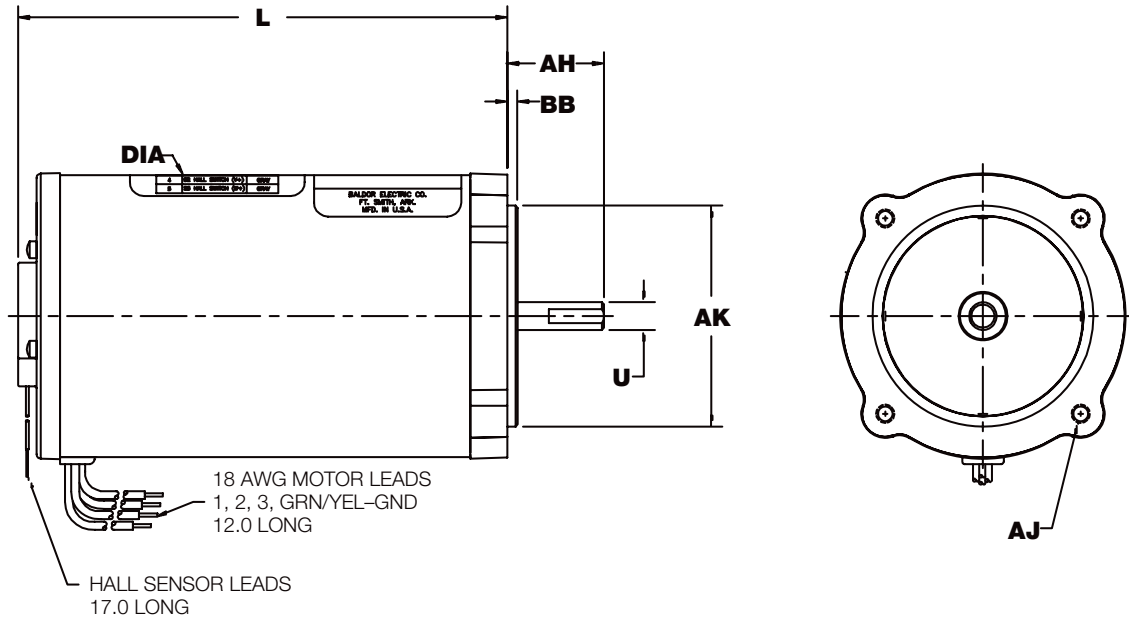

### BSM33 Series

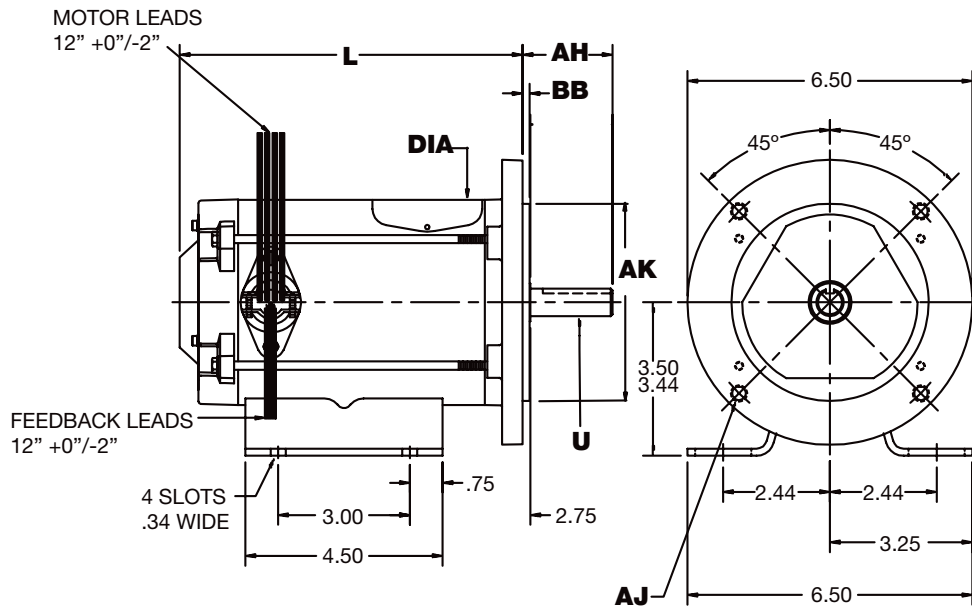

## BSM25/33 Series Dimensions - NEMA Dimensions

Dimensions in mm (inch)

64

Motor Code	Configuration	Body Dia	U	AH	Key	AJ	AK	BB
BSM25C	42C Face	3.88 (98.5)	0.375 (9.5)	1.31 (33.2)	0.75	4x 1/4-20 UNC-2B on a 3.75 B.C.	3 (76.2)	0.14 (3.5)
BSM33C	56C Face	4.66 (118)	0.625 (15.8)	2.5 (63.5)	0.19 x 1.38	4x 0.38-16 tap on 5.875 B.C.	4.5 (114)	0.13 (3.3)

Motor Code	Length - L		
	Resolver	Encoder	Resolver
BSM25C-1	6.64 (169)	-	-
BSM25C-2	7.1 (180)	-	-
BSM33C-2	7.8 (198)	8.56 (217)	7.8 (198)
BSM33C-2	7.8 (198)	8.56 (217)	7.8 (198)
BSM33C-2	10.1 (257)	10.81 (275)	10.1 (257)
BSM33C-2	13.1 (333)	13.81 (351)	13.1 (333)
BSM33C-2	13.1 (333)	13.81 (351)	13.1 (333)

Standard configuration: All motors supplied with Hall sensors and flying leads..

BSM25 has NEMA 42C face; power leads 12" (304mm); Hall sensor leads 17" (431mm)

BSM33 has NEMA 56C face/foot; power leads 12" (304mm); Hall sensor leads 12" (304)

Dimensions are for reference only and may change for other selected options. Detailed engineering drawings available upon request

# Precision Gearheads

## Designed specifically for BSM Servo Motors

**Planetary gearheads** designed for servo applications requiring precision, durability and long trouble free operation. These are high efficiency gearheads to maximize the power transmission capability. Designed with low backlash to reduce shock loads in dynamic reversing applications. They mount directly to Baldor's BSM servo motor family to provide torque multiplication, speed reduction and inertia matching.

- › Standard servo rated gearheads
- › Stainless steel gearheads
- › Standard and lower backlash available
- › Right angle gearheads available
- › High efficiency



**Page67**

**MRP-Series**

MRP - Series Standard 10 to 15 arc-min backlash



**Page73**

**MNT-Series**

MNT - Series higher torque 6-15 arc-min backlash



Page79

MRA-Series

MRA - Series right angle servo gearheads



Page85

MSS-Series

MSS - Series stainless steel servo rated gearheads

# Standard Servo Rated Gearheads - MRP Series

These planetary gearheads provide a standard backlash of 15-10 arc min and are designed for mounting directly on to Baldor's BSM servo motors. These efficient gearheads will maximize power transmission capability in applications.



## Standard Gearhead

- › Standard backlash is 15 to 10 arc-min max
- › Round face with tapped holes
- › Integrated, self-locating input pinion clamps onto motor shaft
- › Lubrication - grease - 15 K hours
- › Satellite gear shaft is cantilever supported in carrier (needle bearings)
- › Satellite gear teeth - deep case hardened and finish ground
- › Medium to high torque/size & torsional stiffness
- › Gearhead housing - aluminum input module, steel output module ›
- › IP64

# Quick Selection Guide for Standard MRP Servo Rated Gearheads

10 to 15 arc min backlash

MOTOR	SELECTION CHART FOR BSM C-SERIES AND STANDARD GEARHEADS (MRP)												
BSM Series	1 Stage Ratios					2 Stage Ratios							
	3	4	5	7	10	16	20	25	35	40	50	70	100
80C - 1XX	090	090	090	090	090	090	090	090	090	090	120	120	155
80C - 2XX	090	090	090	090	090	090	120	120	120	120	120	155	*
80C - 3XX	090	090	090	090	120	120	120	120	120	120	155	155	*
80C - 4XX	090	090	090	090	120	120	120	120	120	155	155	*	*

90C - 1XX	120	120	120	120	120	120	120	120	120	120	120	155	*
90C - 2XX	120	120	120	120	120	120	120	120	120	155	155	155	*
90C - 3XX	120	120	120	120	155	120	120	155	155	*	*	*	*

100C - 1XXX	120	120	120	120	120	120	120	120	120	155	155	*	*
100C - 2XXX	120	120	120	120	155	120	155	155	*	*	*	*	*
100C - 3XXX	120	120	120	120	155	155	155	*	*	*	*	*	*
100C - 4XXX	120	120	120	155	*	*	*	*	*	*	*	*	*
100C - 5XXX	120	120	155	*	*	*	*	*	*	*	*	*	*
100C - 6XXX	120	120	155	*	*	*	*	*	*	*	*	*	*

Ordering nomenclature: for Gearhead only

G BSM80 - MRP090 - 4  
 Gear Motor Gearhead type Ratio

MOTOR	SELECTION CHART FOR BSM N-SERIES AND STANDARD GEARHEADS (MRP)												
BSM Series	1 Stage Ratios					2 Stage Ratios							
	3	4	5	7	10	16	20	25	35	40	50	70	100
50N - 1XX	070	050	050	050	050	050	070	090	090	090	090	090	*
50N - 2XX	070	050	050	070	070	070	090	090	090	090	090	*	*
50N - 3XX	070	050	070	070	070	090	090	090	090	090	*	*	*

63N - 1XX	070	070	070	070	070	070	070	090	090	090	090	120	120
63N - 2XX	070	070	070	070	070	090	090	090	090	120	120	120	*
63N - 3XX	070	070	070	070	090	090	090	120	120	120	120	120	*

80N - 1XX	090	090	090	090	090	090	090	090	120	120	120	120	155
80N - 2XX	090	090	090	090	090	090	120	120	120	120	120	155	*
80N - 3XX	090	090	090	090	120	120	120	120	120	155	155	*	*

90N - 1XX	120	120	120	120	120	120	120	120	155	155	155	*	*
90N - 2XX	120	120	120	120	155	120	155	155	*	*	*	*	*
90N - 3XX	120	120	120	120	155	155	155	155	*	*	*	*	*

100N - 1XXX	120	120	120	120	155	155	155	*	*	*	*	*	*
100N - 2XXX	120	120	120	155	*	*	*	*	*	*	*	*	*
100N - 3XXX	120	120	155	155	*	*	*	*	*	*	*	*	*
100N - 4XXX	120	120	155	*	*	*	*	*	*	*	*	*	*

Ordering nomenclature: for Gearhead only

G BSM50 - MRP050 - 10  
 Gear Motor Gearhead type Ratio

Also Refer to "Quick Selection" in engineering information section.

# Characteristics of Standard Planetary Gearheads

## MRP 050

No of Stages		1 - Stage					2 - Stages						
Ratio		4	5	7	10	16	20	25	35	40	50	70	100
<b>INPUT</b>													
Rated speed / Max.	rpm												
Power in @ T1 & N1 rated	Kw	0.67	0.54	0.29	0.21	0.21	0.13	0.13	0.08	0.04	0.04	0.04	0.04
Rated torque (T1)	Lb-in	14.2	11.5	6.2	4.4	4.4	2.7	2.7	1.8	0.88	0.88	0.88	0.88
	Nm	1.6	1.3	0.7	0.5	0.5	0.3	0.3	0.2	0.1	0.1	0.1	0.1
Accel torque <sup>(1)</sup>	Lb-in	27.4	22.1	13.3	8.8	7.1	5.3	4.4	2.7	2.7	1.8	1.8	0.88
	Nm	3.1	2.5	1.5	1	0.8	0.6	0.5	0.3	0.3	0.2	0.2	0.1
<b>OUTPUT</b>													
Rated speed	rpm	1000	800	571	400	250	200	160	114	100	80	57	57
Rated torque (T2)	Lb-in	53	53	44	44	62	53	53	44	44	44	44	44
	Nm	6	6	5	5	7	6	6	5	5	5	5	5
Accel torque <sup>(1)</sup>	Lb-in	106	106	88	88	106	106	106	88	88	88	88	88
	Nm	12	12	10	10	12	12	12	10	10	10	10	10
<b>GENERAL DATA</b>													
Inertia <sup>(2)</sup>	Lb-in-s <sup>2</sup> x10 <sup>-4</sup>	0.65	0.65	0.62	0.62	0.58	0.58	0.58	0.56	0.53	0.53	0.53	0.53
	Kg-m <sup>2</sup> x10 <sup>-5</sup>	0.74	0.74	0.70	0.70	0.65	0.65	0.65	0.63	0.60	0.60	0.60	0.60
Max. Backlash	arc-mins	12					15						
Efficiency	% <sup>(3)</sup>	96					91						
Rated Life	H	15,000											
Weight	Kg / Lbf	0.9/2					1.2/2.7						
Radial Load <sup>(4)</sup>	N / Lbf	700/157											
Axial Load	N / Lbf	700/157											

## MRP 070

No of Stages		1 - Stage					2 - Stages							
Ratio		3	4	5	7	10	16	20	25	35	40	50	70	100
<b>INPUT</b>														
Rated speed / Max.	rpm	4000 / 6000												
Power in @ T1 & N1 rated	Kw	1.5	1.1	0.9	0.7	0.4	0.6	0.4	0.3	0.2	0.2	0.2	0.1	0.05
Rated torque (T1)	Lb-in	48.7	37.2	29.2	19.5	13.3	11.5	7.1	6.2	3.5	3.5	2.7	1.8	0.88
	Nm	5.5	4.2	3.3	2.2	1.5	1.3	0.8	0.7	0.4	0.4	0.3	0.2	0.1
Accel torque <sup>(1)</sup>	Lb-in	97.4	73.5	58.4	38.1	26.6	18.6	15.0	12.4	8.0	6.2	5.3	5.3	2.7
	Nm	11	8.3	6.6	4.3	3	2.1	1.7	1.4	0.9	0.7	0.6	0.6	0.3
<b>OUTPUT</b>														
Rated speed	rpm	1333	1000	800	571	400	250	200	160	114	100	80	57	57
Rated torque (T2)	Lb-in	142	142	142	133	133	177	142	142	133	133	133	133	133
	Nm	16	16	16	15	15	20	16	16	15	15	15	15	15
Accel torque <sup>(1)</sup>	Lb-in	283	283	283	257	257	283	283	283	257	257	257	257	257
	Nm	32	32	32	29	29	32	32	32	29	29	29	29	29
<b>GENERAL DATA</b>														
Inertia <sup>(2)</sup>	Lb-in-s <sup>2</sup> x10 <sup>-4</sup>	0.956	0.947	0.867	0.805	0.779	0.912	0.938	0.797	0.779	0.770	0.770	0.770	0.752
	Kg-m <sup>2</sup> x10 <sup>-5</sup>	1.08	1.07	0.98	0.91	0.88	1.03	1.06	0.90	0.88	0.87	0.87	0.87	0.85
Max. Backlash	arc-mins	12					15							
Efficiency <sup>(3)</sup>	%	96					94							
Rated Life	H	15,000												
Weight	Kg / Lbf	1.5/3.3					2/4.4							
Radial Load <sup>(4)</sup>	N / Lbf	1500/337												
Axial Load	N / Lbf	1500/337												

Note: (1) S5 duty service. (2) On the motorside. (3) Theoretical gear efficiency value.

(4) Load applied in the middle of the output shaft at 300 rpm.

(5) Emergency Stop Torque is 2.5 times Rated Output Torque for 1000 times max during the service life of the gearhead.



# Characteristics of Standard Planetary Gearheads

## MRP 090

70

No of Stages		1 - Stage					2 - Stages							
Ratio		3	4	5	7	10	16	20	25	35	40	50	70	100
<b>INPUT</b>														
Rated speed / Max.	rpm	4000 / 6000												
Power in @ T1 & N1 rated	Kw	6.2	4.7	4	2.5	1.2	1.3	1	0.7	0.5	0.5	0.4	0.3	0.1
Rated torque (T1)	Lb-in	150	115	97.4	62	27	31	24.8	15.9	13.3	11.5	8.8	5.3	2.7
	Nm	17	13	11	7	3	3.5	2.8	1.8	1.5	1.3	1	0.6	0.3
Accel torque <sup>(1)</sup>	Lb-in	248	186	150	97.4	66.4	48.7	39.8	31	22.1	18	18	8.8	7.1
	Nm	28	21	17	11	7.5	5.5	4.5	3.5	2.5	2	2	1	0.8
<b>OUTPUT</b>														
Rated speed	rpm	1167	875	700	500	350	219	175	140	100	87.5	70	50	35
Rated torque (T2)	Lb-in	443	443	443	443	310	443	443	443	443	443	443	310	310
	Nm	50	50	50	45	35	50	50	50	50	50	50	35	35
Accel torque <sup>(1)</sup>	Lb-in	708	708	708	637	637	708	708	708	708	708	708	637	637
	Nm	80	80	80	72	72	80	80	80	80	80	80	72	72
<b>GENERAL DATA</b>														
Inertia <sup>(2)</sup>	Lb-in-s <sup>2</sup> x10 <sup>-4</sup>	4.6	4.6	4.5	4.2	4.1	4.4	4.4	4.4	4.2	4.2	4.0	3.8	3.8
	Kg-m <sup>2</sup> x10 <sup>-5</sup>	5.2	5.2	5.1	4.8	4.6	5	5	5	4.7	4.7	4.5	4.3	4.3
Max. Backlash	arc-mins	10					12							
Efficiency <sup>(3)</sup>	%	96					91							
Rated Life	H	15,000												
Weight	Kg / Lbf	3/6.6					4/8.8							
Radial Load <sup>(4)</sup>	N / Lbf	2500/562												
Axial Load	N / Lbf	2000/450												

## MRP 120

No of Stages		1 - Stage					2 - Stages							
Ratio		3	4	5	7	10	16	20	25	35	40	50	70	100
<b>INPUT</b>														
Rated speed / Max.	rpm	4000 / 6000												
Power in @ T1 & N1 rated	Kw	15	12	8.5	5	3	3	2.5	2	1.5	1	0.8	0.6	0.3
Rated torque (T1)	Lb-in	478	372	266	159	84.1	97.4	80	62	44	35	27	18	8.8
	Nm	54	42	30	18	9.5	11	9	7	5	4	3	2	1
Accel torque <sup>(1)</sup>	Lb-in	611	460	363	416	168	124	115	97.4	71	53	44	27	18
	Nm	69	52	41	47	19	14	13	11	8	6	5	3	2
<b>OUTPUT</b>														
Rated speed	rpm	1000	750	600	429	300	187.5	150	120	85.5	75	60	43	30
Rated torque (T2)	Lb-in	1372	1416	1283	1062	797	1416	1443	1407	1407	1283	1204	1124	805
	Nm	155	160	145	120	90	160	163	159	159	145	136	127	91
Accel torque <sup>(1)</sup>	Lb-in	1770	1770	1770	1593	1593	1814	2080	2213	2257	1903	1991	1593	1593
	Nm	200	200	200	180	180	205	235	250	255	215	225	180	180
<b>GENERAL DATA</b>														
Inertia <sup>(2)</sup>	Lb-in-s <sup>2</sup> x10 <sup>-4</sup>	15.6	15.6	14.7	14.6	14.0	150	14.9	14.7	14.3	14.3	13.8	13.8	13.8
	Kg-m <sup>2</sup> x10 <sup>-5</sup>	17.6	17.6	16.6	16.5	15.8	16.9	16.8	16.6	16.2	16.2	15.6	15.6	15.6
Max. Backlash	arc-mins	10					12							
Efficiency <sup>(3)</sup>	%	96					91							
Rated Life	H	15,000												
Weight	Kg / Lbf	7/15.4					9/19.8							
Radial Load <sup>(4)</sup>	N / Lbf	4500/1010												
Axial Load	N / Lbf	4000/900												

Note: (1) S5 duty service. (2) On the motorside. (3) Theoretical gear efficiency value.

(4) Load applied in the middle of the output shaft at 300 rpm.

(5) Emergency Stop Torque is 2.5 times Rated Output Torque for 1000 times max during the service life of the gearhead.

# Characteristics of Standard Planetary Gearheads

## MRP 155

No of Stages		1 - Stage					2 - Stages							
Ratio		3	4	5	7	10	16	20	25	35	40	50	70	100
<b>INPUT</b>														
Rated speed / Max.	rpm	4000 / 6000												
Power in @ T1 & N1 rated	Kw	15	16	13	8	4	4	3.5	3	2	1.5	1.5	0.8	0.4
Rated torque (T1)	Lb-in	646	673	540	336	159	177	142	115	80	62	53	35	18
	Nm	73	76	61	38	18	20	16	13	9	7	6	4	2
Accel torque <sup>(1)</sup>	Lb-in	1230	920	735	460	292	239	195	150	106	97.4	71	44	27
	Nm	139	104	83	52	33	27	22	17	12	11	8	5	3
<b>OUTPUT</b>														
Rated speed	rpm	666	500	400	285	200	125	100	80	57	50	40	28	20
Rated torque (T2)	Lb-in	1859	2567	2567	2257	1505	2567	2567	2567	2390	2213	2213	2213	1505
	Nm	210	290	290	255	170	290	290	290	270	250	250	230	170
Accel torque <sup>(1)</sup>	Lb-in	3540	3540	3540	3098	2832	3540	3540	3540	3540	3540	3540	2832	2832
	Nm	400	400	400	350	320	400	400	400	400	400	400	320	320
<b>GENERAL DATA</b>														
Inertia <sup>(2)</sup>	Lb-in-s <sup>2</sup> x10 <sup>-4</sup>	33.6	31	31	27.4	25.7	32.7	32.7	30.1	28.3	26.6	24.8	24.8	24.8
	Kg-m <sup>2</sup> x10 <sup>-5</sup>	38	35	35	31	29	37	37	34	32	30	28	28	28
Max. Backlash	arc-mins	10					12							
Efficiency <sup>(3)</sup>	%	96					91							
Rated Life	H	15,000												
Weight	Kg / Lbf	10/22					15/33							
Radial Load <sup>(4)</sup>	N / Lbf	7500/1690												
Axial Load	N / Lbf	6000/1350												

Note: (1) S5 duty service. (2) On the motorside. (3) Theoretical gear efficiency value.  
 (4) Load applied in the middle of the output shaft at 300 rpm.  
 (5) Emergency Stop Torque is 2.5 times Rated Output Torque for 1000 times max during the service life of the gearhead.

# Standard Gearhead Dimensions

**GBSM50-MRP050-XX**

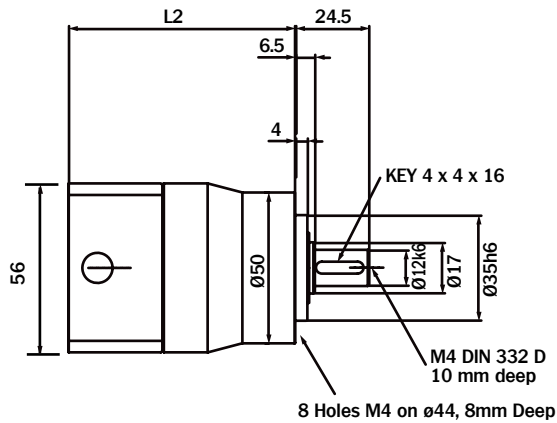

**GBSM100-MRP120-XX**

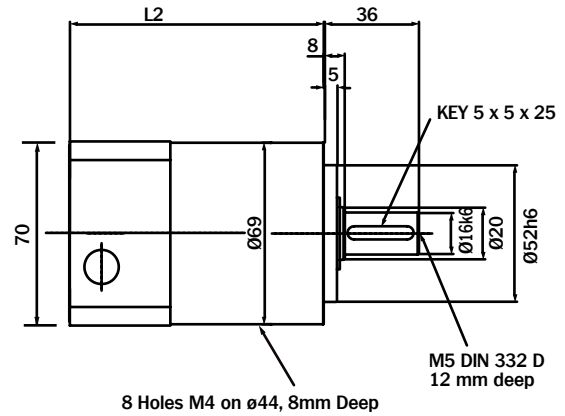

**GBSM80-MRP090**

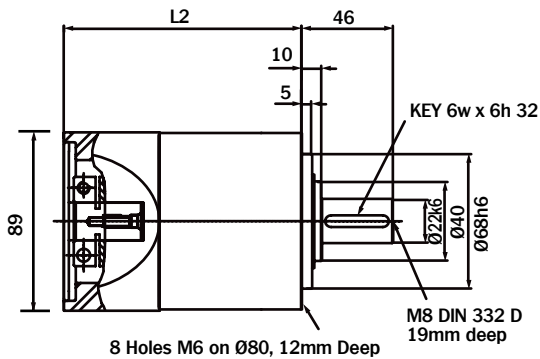

**GBSM90-MRP120-XX**

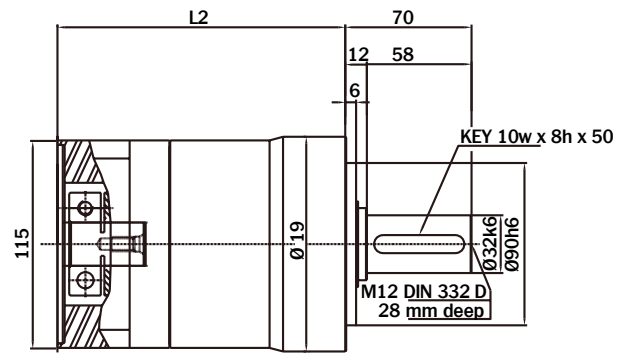

**GBSM63-MRP070-XX**

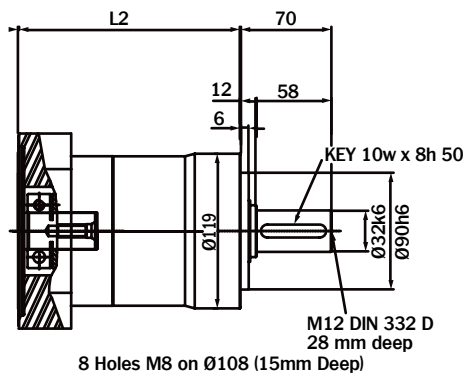

# Standard Gearhead Dimensions

Gear Number	No. of Stages	"L2" Length (mm)
MRP050	1	70
	2	97
MRP070	1	96
	2	113
MRP090	1	121
	2	157
MRP120	1	160
	2	202
MRP155	1	185
	2	225

**Note:** "XX" insert specific gear ratios. Verify that motor torque does not exceed gear rated input torque. Other BSM and gearhead possibility exist. Contact Baldor with your requirements. Dimensions in mm.

# Higher Torque/Lower Backlash Servo Rated Gearheads - MNT Series

These planetary servo rated gearheads provide a higher rated torque input and output capability along with lower backlash of 6-15 arc-min, with optional 3-5 arc-min backlash. These are highly efficient gearheads. They are designed to mount directly to Baldor's BSM servo motors.



## Higher Torque/Lower Backlash Gearhead

- › Higher rated torque and higher acceleration torque capability
- › Backlash of 6 to 15 arc-min; lower optional 3 to 5 arc-min
- › Square flange
- › Integrated, self-locating input pinion clamps onto motor shaft
- › Lubrication - grease - 15 K hours
- › Satellite gear shaft is double supported in carrier (needle bearings)
- › Satellite gear teeth - deep case hardened and finish ground
- › Highest torque/size & torsional stiffness
- › Gearhead housing - all steel
- › IP64

# Quick Selection Guide for Higher Torque MNT Servo Gearheads

6 to 15 arc min backlash

74

MOTOR	SELECTION CHART FOR BSM C-SERIES AND HIGHER TORQUE GEARHEADS (MNT)													
	BSM Series	1 Stage Ratios					2 Stage Ratios							
		3	4	5	7	10	16	20	25	35	40	50	70	100
80C – 1XX	080	080	080	080	080	080	080	080	080	080	080	080	115	115
80C – 2XX	080	080	080	080	080	080	080	080	080	080	115	115	115	140
80C – 3XX	080	080	080	080	080	080	080	080	080	115	115	115	115	*
80C – 4XX	080	080	080	080	080	080	080	080	115	115	115	115	140	*

90C – 1XX	115	115	115	115	115	115	115	115	115	115	115	115	115	140
90C – 2XX	115	115	115	115	115	115	115	115	115	115	115	115	140	180
90C – 3XX	115	115	115	115	115	115	115	115	115	115	140	140	180	180

100C – 1XXX	115	115	115	115	115	115	115	115	115	115	115	115	140	180
100C – 2XXX	115	115	115	115	115	115	115	115	115	140	140	140	210	*
100C – 3XXX	115	115	115	115	115	115	115	115	140	140	180	180	*	*
100C – 4XXX	115	115	115	115	115	115	140	140	140	180	210	210	*	*
100C – 5XXX	115	115	115	115	115	115	140	140	180	210	210	*	*	*
100C – 6XXX	140	140	140	140	140	140	180	180	180	210	*	*	*	*

Ordering nonmenclature: for Gearhead only

G BSM80 - MNT080 - 10  
 Gear Motor Gearhead type Ratio

MOTOR	SELECTION CHART FOR BSM N-SERIES AND HIGHER TORQUE GEARHEADS (MNT)													
	BSM Series	1 Stage Ratios					2 Stage Ratios							
		3	4	5	7	10	16	20	25	35	40	50	70	100
50N – 1XX	065	065	065	065	065	065	065	065	065	065	065	065	080	080
50N – 2XX	065	065	065	065	065	065	065	065	065	065	080	080	080	*
50N – 3XX	065	065	065	065	065	065	065	065	080	080	080	080	*	*

63N – 1XX	065	065	065	065	065	065	065	065	065	080	080	080	080	115
63N – 2XX	065	065	065	065	065	065	065	065	080	080	080	080	115	115
63N – 3XX	065	065	065	065	065	065	065	080	080	080	080	080	115	115

80N – 1XX	080	080	080	080	080	080	080	080	080	080	080	080	115	115
80N – 2XX	080	080	080	080	080	080	080	080	080	115	115	115	115	140
80N – 3XX	080	080	080	080	080	080	080	080	115	115	115	115	140	*

90N – 1XX	115	115	115	115	115	115	115	115	115	115	115	115	140	180
90N – 2XX	115	115	115	115	115	115	115	115	115	140	140	140	180	*
90N – 3XX	115	115	115	115	115	115	115	115	140	140	180	180	210	*

100N – 1XXX	115	115	115	115	115	115	115	140	140	180	180	210	*	*
100N – 2XXX	115	115	115	115	140	140	140	140	210	210	*	*	*	*
100N – 3XXX	115	115	115	140	180	180	180	210	*	*	*	*	*	*
100N – 4XXX	115	115	115	140	*	210	210	210	*	*	*	*	*	*

Ordering nonmenclature: for Gearhead only

G BSM80 - MNT065 - 10  
 Gear Motor Gearhead type Ratio

Also Refer to “Quick Selection” in engineering information section.

# Characteristics of Higher Torque Gearheads

## MNT 065

No of Stages		1 - Stage					2 - Stages							
Ratio		3	4	5	7	10	16	20	25	35	50	70	100	
<b>INPUT</b>														
Rated speed / Max.	rpm	4000 / 6000												
Power in @ T1 & N1 rated	Kw	1.87	1.87	1.56	1.19	0.67	1.00	0.67	0.54	.039	0.26	0.16	0.08	
Rated torque (T1)	Lb-in	60.6	45.6	36.3	27.4	17.3	21.2	14.1	11.2	8.1	5.7	3.5	1.8	
	Nm	6.85	5.15	4.10	3.10	1.95	2.40	1.59	1.27	0.91	0.64	0.39	0.20	
Accel torque <sup>(1)</sup>	Lb-in	118.0	88	66.8	47.8	28.8	28.0	19.5	15.6	11.7	8.1	5.6	3.1	
	Nm	13.35	10	7.55	5.40	3.25	3.16	2.20	1.76	1.32	0.92	0.63	0.35	
<b>OUTPUT</b>														
Rated speed	rpm	1333	1000	800	571	400	250	200	160	114	80	57	40	
Rated torque (T2)	Lb-in	174	174	174	184	165	310	257	257	257	257	221	159	
	Nm	19.7	19.7	19.7	20.8	18.7	35	29	29	29	29	25	18	
Accel torque <sup>(1)</sup>	Lb-in	336	336	319	319	274	407	354	354	372	372	354	283	
	Nm	38	38	36	36	31	46	40	40	42	42	40	32	
<b>GENERAL DATA</b>														
Inertia <sup>(2)</sup>	Lb-in-s <sup>2</sup> x10 <sup>-4</sup>	3.7	3.7	3.7	3.44	3.31	3.62	3.4	3.57	3.4	3.3	3.3	3.3	
	Kg-m <sup>2</sup> x10 <sup>-5</sup>	3.30	3.30	3.27	3.04	2.93	3.20	3.00	3.16	3.00	2.90	2.90	2.90	
Max. Backlash	arc-mins	15 or 5												
Efficiency <sup>(3)</sup>	%	96					91							
Rated Life	H	15,000												
Weight	Kg / Lbf	1.7/3.8					2.2/4.9							
Radial Load <sup>(4)</sup>	N / Lbf	1500/337												
Axial Load	N / Lbf	1300/292												

## MNT 080

No of Stages		1 - Stage					2 - Stages							
Ratio		3	4	5	7	10	16	20	25	35	40	50	70	100
<b>INPUT</b>														
Rated speed / Max.	rpm	4000 / 6000												
Power in @ T1 & N1 rated	Kw	12.3	9.2	7.4	4.3	2.2	2.5	1.9	1.6	1.2	0.9	0.8	0.5	0.2
Rated torque (T1)	Lb-in	261	196	157	92	46	52	42	33	24	20	17	12	4.4
	Nm	29.5	22.1	17.7	10.4	5.2	5.9	4.7	3.7	2.7	2.3	1.9	1.3	0.5
Accel torque <sup>(1)</sup>	Lb-in	336	257	186	133	71	80	62	53	35	31	27	18	9
	Nm	38	29	21	15	8	9	7	6	4	3.5	3	2	1
<b>OUTPUT</b>														
Rated speed	rpm	1333	1000	800	571	400	250	200	160	114	100	80	57	40
Rated torque (T2)	Lb-in	752	752	752	619	442	761	752	752	761	752	752	619	442
	Nm	85	85	85	70	50	86	85	85	86	85	85	70	50
Accel torque <sup>(1)</sup>	Lb-in	973	973	885	885	708	1106	1115	1150	1186	1115	1115	885	708
	Nm	110	110	100	100	80	125	126	130	134	126	126	100	80
<b>GENERAL DATA</b>														
Inertia <sup>(2)</sup>	Lb-in-s <sup>2</sup> x10 <sup>-4</sup>	12.8	12.8	11.8	10.8	10.5	12.2	12.1	11.3	10.6	10.3	12.2	12.2	12.1
	Kg-m <sup>2</sup> x10 <sup>-5</sup>	11.3	11.3	10.4	9.6	9.3	10.8	10.7	10	9.4	9.1	10.8	10.8	10.7
Max. Backlash	arc-mins	10, 5 or 1												
Efficiency	% <sup>(3)</sup>	96					91							
Rated Life	H	15,000												
Weight	Kg / Lbf	3 / 6.7					4 / 8.9							
Radial Load <sup>(4)</sup>	N / Lbf	3,500 / 787												
Axial Load	N / Lbf	3,000 / 675												

Note: (1) S5 duty service. (2) On the motorside. (3) Theoretical gear efficiency value.

(4) Load applied in the middle of the output shaft at 300 rpm.

(5) Emergency Stop Torque is 2.5 times Rated Output Torque for 1000 times max during the service life of the gearhead.

# Characteristics of Higher Torque Gearheads

## MNT 115

76

No of Stages		1 - Stage					2 - Stages							
Ratio		3	4	5	7	10	16	20	25	35	40	50	70	100
<b>INPUT</b>														
Rated speed / Max.	rpm	4000 / 6000												
Power in @ T1 & N1 rated	Kw	31.4	31.4	22.2	12.6	6.3	8.3	6.7	5	3.8	2.5	2.1	1.7	1.4
Rated torque (T1)	Lb-in	796	619	442	265	133	177	142	106	80	62	53	35	18
	Nm	90	70	50	30	15	20	16	12	9	7	6	4	2
Accel torque <sup>(1)</sup>	Lb-in	920	717	496	327	186	204	186	150	115	80	71	44	27
	Nm	104	81	56	37	21	23	21	17	13	9	8	5	3
<b>OUTPUT</b>														
Rated speed	rpm	1333	1000	800	571	400	250	200	160	114	100	82	57	40
Rated torque (T2)	Lb-in	2390	2390	2115	1673	1195	2390	2390	2257	2372	2257	2264	2265	1593
	Nm	270	270	239	189	135	270	270	255	268	255	256	256	180
Accel torque <sup>(1)</sup>	Lb-in	2708	2743	2390	2212	1770	3009	3380	3407	3451	2743	2743	2832	2390
	Nm	306	310	270	250	200	340	382	385	390	310	310	320	270
<b>GENERAL DATA</b>														
Inertia <sup>(2)</sup>	Lb-in-s <sup>2</sup> x10 <sup>-4</sup>	50.2	50.2	45.7	41.6	39.7	47.8	47	44	41	39.2	47.6	47.6	47.3
	Kg-m <sup>2</sup> x10 <sup>-5</sup>	44.4	44.4	40.4	36.8	35.1	42.3	42	38.9	36	34.7	42.1	42.1	41.9
Max. Backlash	arc-mins	10, 5 or 1												
Efficiency	% <sup>(3)</sup>	96					91							
Rated Life	H	15000												
Weight	Kg / Lbf	7.5/16.5					9/20							
Radial Load <sup>(4)</sup>	N / Lbf	5500/1237												
Axial Load	N / Lbf	5000/1124												

## MNT 140

No of Stages		1 - Stage					2 - Stages							
Ratio		3	4	5	7	10	16	20	25	35	40	50	70	100
<b>INPUT</b>														
Rated speed / Max.	rpm	4000 / 6000												
Power in @ T1 & N1 rated	Kw	41.9	41.9	40.1	22.9	11.3	12.1	12.1	9.6	6.7	4.6	3.4	2.9	2.5
Rated torque (T1)	Lb-in	1106	885	850	487	239	257	257	204	142	106	88	53	27
	Nm	125	100	96	55	27	29	29	23	16	12	10	6	3
Accel torque <sup>(1)</sup>	Lb-in	1531	1150	920	655	363	301	274	221	150	133	106	71	35
	Nm	173	130	104	74	41	34	31	25	17	15	12	8	4
<b>OUTPUT</b>														
Rated speed	rpm	1333	1000	800	571	400	250	200	160	114	100	82	57	40
Rated torque (T2)	Lb-in	3186	3398	3982	3265	2292	3487	4363	4327	4212	3982	3982	3363	2416
	Nm	360	384	450	369	259	394	493	489	476	450	450	380	273
Accel torque <sup>(1)</sup>	Lb-in	4425	4425	4425	4425	3540	4425	4956	4956	4780	4832	4876	4425	3186
	Nm	500	500	500	500	400	500	560	560	540	546	550	500	360
<b>GENERAL DATA</b>														
Inertia <sup>(2)</sup>	Lb-in-s <sup>2</sup> x10 <sup>-4</sup>	107	101	97	87	81	103	103	96	90	85	79	79	79
	Kg-m <sup>2</sup> x10 <sup>-5</sup>	95	89	86	77	72	91	91	85	80	75	70	70	70
Max. Backlash	arc-mins	10, 5 or 1												
Efficiency	% <sup>(3)</sup>	96					91							
Rated Life	H	15,000												
Weight	Kg / Lbf	9/20					17/38							
Radial Load <sup>(4)</sup>	N / Lbf	9,100/2,046												
Axial Load	N / Lbf	9,100/2,046												

Note: (1) S5 duty service. (2) On the motorside. (3) Theoretical gear efficiency value.

(4) Load applied in the middle of the output shaft at 300 rpm.

(5) Emergency Stop Torque is 2.5 times Rated Output Torque for 1000 times max during the service life of the gearhead.



# Characteristics of Higher Torque Gearheads

## MNT 180

No of Stages		1 - Stage					2 - Stages							
Ratio		3	4	5	7	10	16	20	25	35	40	50	70	100
<b>INPUT</b>														
Rated speed / Max.	rpm	4000 / 6000												
Power in @ T1 & N1 rated	Kw	56.5	56.5	56.5	34.3	16.7	15.9	15.9	12.5	9.2	6.2	4.1	4.1	3.3
Rated torque (T1)	Lb-in	1681	1265	1195	726	504	336	336	265	195	133	133	71	53
	Nm	190	143	135	82	57	38	38	30	22	15	15	8	6
Accel torque <sup>(1)</sup>	Lb-in	3097	2301	1841	1390	735	711	487	389	274	239	195	142	80
	Nm	350	260	208	157	83	69	55	44	31	27	22	16	9
<b>OUTPUT</b>														
Rated speed	rpm	667	500	400	286	200	125	100	80	57	50	40	29	20
Rated torque (T2)	Lb-in	4867	4867	5752	4867	4867	4894	6115	6035	6195	4823	6018	4867	4867
	Nm	550	550	650	550	550	553	691	682	700	545	680	550	550
Accel torque <sup>(1)</sup>	Lb-in	8850	8850	8850	8850	7080	8850	8850	8850	8850	8850	8850	8850	7080
	Nm	1000	1000	1000	1000	800	1000	1000	1000	1000	1000	1000	1000	1000
<b>GENERAL DATA</b>														
Inertia <sup>(2)</sup>	Lb-in-s <sup>2</sup> x10 <sup>-4</sup>	500	296	234	183	156	255	252	206	167	169	147	145	141
	Kg-m <sup>2</sup> x10 <sup>-5</sup>	442	262	207	162	138	226	223	182	148	132	130	128	125
Max. Backlash	arc-mins	6 or 3												
Efficiency	% <sup>(3)</sup>	96					91							
Rated Life	H						15,000							
Weight	Kg / Lbf	45/100					50/112							
Radial Load <sup>(4)</sup>	N / Lbf	14,500/3,260												
Axial Load	N / Lbf	14,000/3,147												

## MNT 210

No of Stages		1 - Stage					2 - Stages							
Ratio		3	4	5	7	10	16	20	25	35	40	50	70	100
<b>INPUT</b>														
Rated speed / Max.	rpm	4000 / 6000												
Power in @ T1 & N1 rated	Kw	145	109	87	62	43	29	23	18	13	11	9	7	4
Rated torque (T1)	Lb-in	3080	2310	1850	1310	920	611	487	389	283	239	195	142	80
	Nm	348	261	209	148	104	69	55	44	32	27	22	16	9
Accel torque <sup>(1)</sup>	Lb-in	5841	4381	1735	1973	1381	1150	920	743	416	363	292	204	142
	Nm	660	495	196	223	156	130	104	84	47	41	33	23	16
<b>OUTPUT</b>														
Rated speed	rpm	667	500	400	286	200	125	100	80	57	50	40	29	20
Rated torque (T2)	Lb-in	8850	8850	8850	8850	8850	8850	8850	8850	8850	8850	8850	8850	8850
	Nm	1000	1000	1000	1000	1000	1000	1000	1000	1000	1000	1000	1000	1000
Accel torque <sup>(1)</sup>	Lb-in	16800	16800	16800	16800	13300	16800	16800	16800	13300	13300	13300	13300	13300
	Nm	1900	1900	1900	1900	1500	1900	1900	1900	1500	1500	1500	1500	1500
<b>GENERAL DATA</b>														
Inertia <sup>(2)</sup>	Lb-in-s <sup>2</sup> x10 <sup>-4</sup>													
	Kg-m <sup>2</sup> x10 <sup>-5</sup>													
Max. Backlash	arc-mins	6 or 3												
Efficiency	% <sup>(3)</sup>	96					91							
Rated Life	H						15,000							
Weight	Kg / Lbf	50/112					55/123							
Radial Load <sup>(4)</sup>	N / Lbf	18,000/4,047												
Axial Load	N / Lbf	18,000/4,047												

Note: (1) S5 duty service. (2) On the motorside. (3) Theoretical gear efficiency value.

(4) Load applied in the middle of the output shaft at 300 rpm.

(5) Emergency Stop Torque is 2.5 times Rated Output Torque for 1000 times max during the service life of the gearhead.

# Higher Torque Gearhead Dimensions

78

**GBSM63-MNT065-XX**

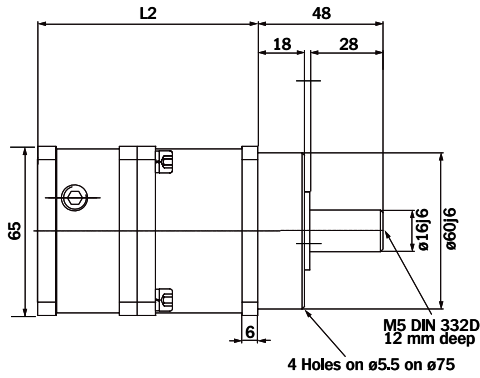

**GBSM100-MNT140-XX**

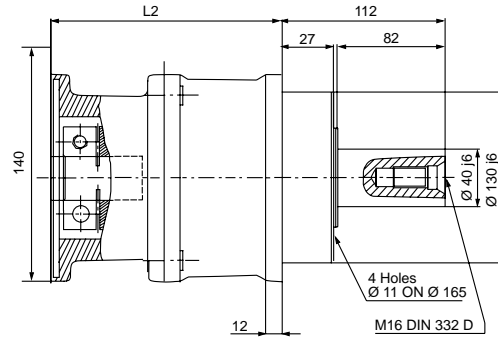

**GBSM80-MNT080-XX**

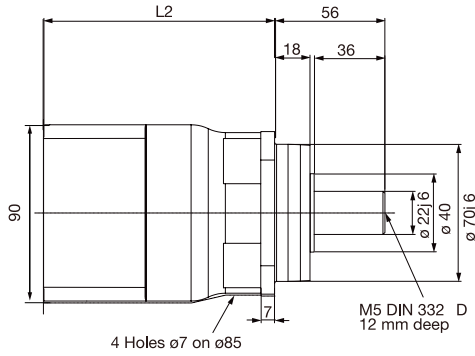

**GBSM100-MNT180-XX**

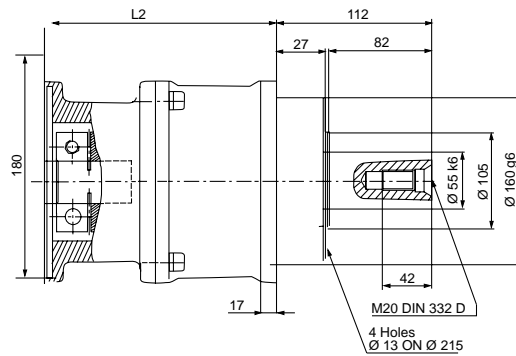

**GBSM90-MNT115-XX**

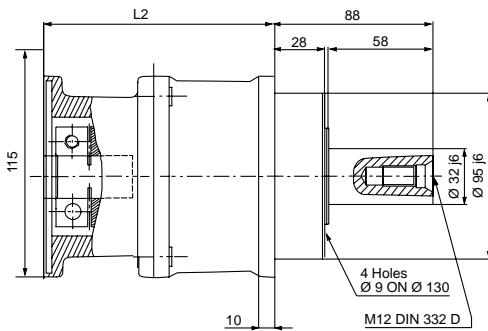

**GBSM100-MNT210-XX**

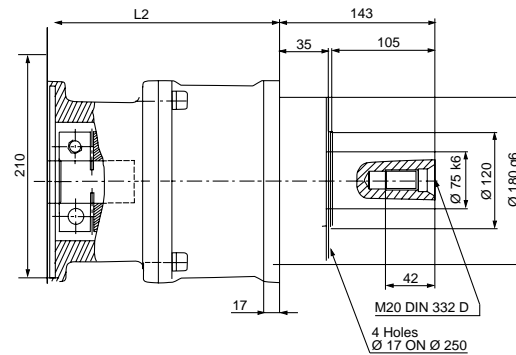

Gear Number	No. of Stages	"L2" Length (mm)
MNT065	1	84
	2	107
MNT080	1	120
	2	156
MNT115	1	130
	2	171
MNT140	1	160
	2	201
MNT180	1	230
	2	295
MNT210	1	260
	2	325

**Note:** "XX" insert specific gear ratios. Verify that motor torque does not exceed gear rated input torque. Other BSM and gearhead possibility exist. Contact Baldor with your requirements. Dimensions in mm.

# Right Angle Servo Rated GearHeads - MRA Series

These servo rated right angle gearheads are heavy duty and provide 15, 10 or 5 arc-min backlash. The planetary input stages are hardened and ground with steel housings for rigidity. The distance from the face mounting to the motor centerline is short, allowing the motor-gearhead to hug the machine frame.



## Right Angle Gearhead

- › Backlash of 5 - 15 arc-min
- › Integrated, self-locating input pinion clamps onto motor shaft
- › Lubrication - in line planetary section oil; bevel gear section metal adhering grease; shaft seal between; - 10 K hours
- › Planetary input stages are hardened and ground, slower speed right-angle has cut and hardened gears
- › Standard output shaft is "smooth shaft" - keyways upon request
- › High torque/size & torsional stiffness
- › Gearhead housing - all steel
- › IP64

# Quick Selection Guide for Right Angle MRA Servo Gearheads

80

MOTOR	SELECTION CHART FOR BSM N-SERIES AND RIGHT ANGLE GEARHEADS (MRA)													
	BSM Series	1 Stage Ratios					2 Stage Ratios							
		3	4	5	7	10	16	20	25	35	40	50	70	100
50N - 1XX	065	065	065	065	065	065	065	065	065	080	080	80	080	
50N - 2XX	065	065	065	065	065	065	065	080	080	080	080	115	*	
50N - 3XX	065	065	080	080	080	080	080	080	080	080	115	115		
63N - 1XX	065	065	065	065	065	065	065	065	080	080	080	115	115	
63N - 2XX	065	065	065	080	080	080	080	080	080	080	115	115	115	
63N - 3XX	065	065	065	080	080	080	080	080	080	080	115	115	115	
80N - 1XX	080	080	080	080	080	080	080	080	080	080	115	115	*	
80N - 2XX	080	080	080	080	080	080	080	080	115	115	140	180	*	
80N - 3XX	080	080	080	080	080	080	080	115	115	140	180	*		
90N - 1XX	115	115	115	115	115	115	115	115	140	180	180	*	*	
90N - 2XX	115	115	115	115	115	115	115	140	180	*	*	*		
90N - 3XX	115	115	115	115	115	115	180	180	*	*	*	*		
100N-1XXX	115	115	115	115	115	140	180	180	*	*	*	*		
100N-2XXX	115	115	115	115	140	180	*	*	*	*	*	*		
100N-3XXX	115	115	115	140	180	*	*	*	*	*	*	*		
100N-4XXX	115	115	140	180	*	*	*	*	*	*	*	*	*	

Ordering nonmenclature: for Gearhead only

G BSM80 - MRA065 - 10  
 Gear Motor Gearhead type Ratio

MOTOR	SELECTION CHART FOR BSM C-SERIES AND RIGHT ANGLE GEARHEADS (MRA)													
	BSM Series	1 Stage Ratios					2 Stage Ratios							
		3	4	5	7	10	16	20	25	35	40	50	70	100
80C - 1XX	080	080	080	080	080	080	080	080	080	080	080	115	080	
80C - 2XX	080	080	080	080	080	080	080	080	080	115	140	180	*	
80C - 3XX	080	080	080	080	080	080	080	080	115	115	140	180		
80C - 4XX	080	080	080	080	080	080	080	115	115	140	180	*	*	
90C - 1XX	115	115	115	115	115	120	115	115	140	180	180	*	115	
90C - 2XX	115	115	115	115	115	120	115	115	140	180	180	*	115	
90C - 3XX	115	115	115	115	115	115	115	115	140	180	*	*	115	
100C - 1XXX	115 +	115 +	115 +	115 +	115 +	115 +	115 +	115 +	115 +	140	180	*	*	
100C - 2XXX	115 +	115 +	115 +	115 +	115 +	115 +	115 +	140	180	*	*	*	*	
100C - 3XXX	115 +	115 +	115 +	115 +	115 +	140	180	180	*	*	*	*		
100C - 4XXX	115 +	115 +	115 +	115 +	140	180	180	*	*	*	*	*		
100C - 5XXX	115 +	115 +	115 +	115 +	180	180	*	*	*	*	*	*	*	
100C - 6XXX	115 +	115 +	115 +	140	180	*	*	*	*	*	*	*	*	

Ordering nonmenclature: for Gearhead only

G BSM80 - MRA080 - 4  
 Gear Motor Gearhead type Ratio

Note: The table suggests using MRA140 for better looking physical match of motor to gearhead Also Refer to "Quick Selection" in engineering information section.

# Characteristics of Right Angle Gearheads

## MRA 065

No of Stages		1 - Stage					2 - Stages						
Ratio		3	4	5	7	10	16	20	25	35	50	70	100
<b>INPUT</b>													
Rated speed / Max.	rpm	4000 / 6000											
Rated Power	Kw	1.05	0.78	0.78	0.55	0.39	0.47	0.39	0.31	0.23	0.16	0.11	0.08
Rated torque	Lb-in	22.1	16.6	17.7	11.5	8.3	10.0	8.4	6.7	5.0	3.4	2.5	1.7
	Nm	2.50	1.88	2.0	1.3	0.94	1.13	0.95	0.76	0.57	0.38	0.28	0.19
Accel torque <sup>(1)</sup>	Lb-in	20.7	20.7	20.7	15.0	10.6	20.4	15.8	13.0	9.2	6.7	5.0	2.5
	Nm	2.34	2.34	2.35	1.7	1.2	2.31	1.79	1.46	1.04	0.76	0.57	0.28
<b>OUTPUT</b>													
Rated speed	rpm	1333	1000	800	571	400	250	200	160	114	80	57	57
Rated torque	Lb-in	64	64	80	80	80	144	150	150	158	148	158	150
	Nm	7.2	7.2	9.0	9.0	9.0	16.3	17.0	17.0	17.9	16.7	17.9	17.0
Accel torque <sup>(1)</sup>	Lb-in	159	159	100	100	100	295	286	291	289	295	316	226
	Nm	9.0	9.0	11.3	11.3	11.3	33.3	32.3	32.9	32.7	33.3	35.7	25.5
<b>GENERAL DATA</b>													
Inertia <sup>(2)</sup>	Lb-in-s <sup>2</sup> x10 <sup>-4</sup>	0.56	0.56	0.34	0.11	0.11	0.45	0.45	0.34	0.34	0.11	0.08	0.08
	Kg-m <sup>2</sup> x10 <sup>-5</sup>	0.50	0.50	0.30	0.10	0.10	0.40	0.40	0.30	0.30	0.10	.070	.070
Max. Backlash	arc-mins	15 or 5											
Efficiency <sup>(3)</sup>	%	96					91						
Rated Life	H	10,000											
Weight	Kg / Lbf	3/6.7					4/8.9						
Radial Load <sup>(4)</sup>	N / Lbf	750/169											
Axial Load	N / Lbf	300/67.4											

## MRA 080

No of Stages		1 - Stage					2 - Stages						
Ratio		3	4	5	7	10	16	20	25	35	50	70	100
<b>INPUT</b>													
Rated speed / Max.	rpm	4000 / 6000											
Rated Power	Kw	9.6	9.6	7.4	3.7	2	2.5	2.0	1.6	1.1	0.79	0.54	0.2
Rated torque	Lb-in	204	204	159	80	44	52	42	33	24	17	12	4.4
	Nm	23	23	18	9	5	5.9	4.7	3.7	2.7	1.9	1.3	0.5
Accel torque <sup>(1)</sup>	Lb-in	265	265	177	97	53	80	62	53	35	26	18	9
	Nm	30	30	20	11	6	9	7	6	4	3	2	1
<b>OUTPUT</b>													
Rated speed	rpm	1333	1000	800	571	400	250	200	160	114	80	57	40
Rated torque	Lb-in	752	752	752	575	442	761	752	752	761	752	442	442
	Nm	85	85	85	65	50	86	85	85	86	85	50	50
Accel torque <sup>(1)</sup>	Lb-in	973	973	796	619	487	1106	1115	1150	1186	885	885	619
	Nm	110	110	90	70	55	125	126	130	134	100	100	70
<b>GENERAL DATA</b>													
Inertia <sup>(2)</sup>	Lb-in-s <sup>2</sup> x10 <sup>-4</sup>	12.8	12.8	11.8	10.8	10.5	12.2	12.1	11.3	10.6	12.2	12.2	12.1
	Kg-m <sup>2</sup> x10 <sup>-5</sup>	11.3	11.3	10.4	9.6	9.3	10.8	10.7	10	9.4	10.8	10.8	10.7
Max. Backlash	arc-mins	10 or 5											
Efficiency <sup>(3)</sup>	%	96					91						
Rated Life	H	15,000											
Weight	Kg / Lbf	5/11.2					6/13.4						
Radial Load <sup>(4)</sup>	N / Lbf	1,600/360											
Axial Load	N / Lbf	650/146											

Note: (1) S5 duty service. (2) On the motorside. (3) Theoretical gear efficiency value.

(4) Load applied in the middle of the output shaft at 300 rpm.

(5) Emergency Stop Torque is 2.5 times Rated Output Torque for 1000 times max during the service life of the gearhead.

# Characteristics of Right Angle Gearheads

## MRA 115

82

No of Stages		1 - Stage					2 - Stages						
Ratio		3	4	5	7	10	16	20	25	35	50	70	100
<b>INPUT</b>													
Rated speed / Max.	rpm	4000 / 6000											
Rated Power	Kw	26	20	16	11	6.3	5	4.2	3.4	2.1	1.5	0.92	0.84
Rated torque	Lb-in	548	416	336	239	133	106	88	71	44	31	19	18
	Nm	62	47	38	27	15	12	10	8	5	3.5	2.2	2
Accel torque <sup>(1)</sup>	Lb-in	761	575	460	257	177	150	115	97	62	46	35	27
	Nm	86	65	52	29	20	17	13	11	7	5.2	4	3
<b>OUTPUT</b>													
Rated speed	rpm	1333	1000	800	571	400	250	200	160	114	80	57	40
Rated torque	Lb-in	1575	1602	1611	1611	1274	1549	1611	1611	1416	1416	1212	1522
	Nm	178	181	182	182	144	175	182	182	160	160	137	172
Accel torque <sup>(1)</sup>	Lb-in	2212	2212	2212	1726	1726	2212	2212	2212	2212	2212	2212	2212
	Nm	250	250	250	195	195	250	250	250	250	250	250	250
<b>GENERAL DATA</b>													
Inertia <sup>(2)</sup>	Lb-in-s <sup>2</sup> x10 <sup>-4</sup>	50.2	50.2	45.6	41.6	39.7	47.8	47.5	44.0	40.7	47.6	47.6	47.3
	Kg-m <sup>2</sup> x10 <sup>-5</sup>	44.4	44.4	40.4	36.8	35.1	42.3	42	38.9	36	42.1	42.1	41.9
Max. Backlash	arc-mins	10 or 5											
Efficiency <sup>(3)</sup>	%	96					91						
Rated Life	H						15,000						
Weight	Kg / Lbf	23/51					25/56						
Radial Load <sup>(4)</sup>	N / Lbf						2,400/540						
Axial Load	N / Lbf						1,000/225						

## MRA 140

No of Stages		1 - Stage					2 - Stages						
Ratio		3	4	5	7	10	16	20	25	35	50	70	100
<b>INPUT</b>													
Rated speed / Max.	rpm	4000 / 6000											
Rated Power	Kw	33	25	20	14	10	6.7	5.5	4.2	3	2.1	1.5	1
Rated torque	Lb-in	708	531	425	301	212	142	115	88	62	44	31	22
	Nm	80	60	48	34	24	16	13	10	7	5	3.5	2.5
Accel torque <sup>(1)</sup>	Lb-in	1221	920	735	389	274	239	195	150	106	71	53	35
	Nm	138	104	83	44	31	27	22	17	12	8	6	4
<b>OUTPUT</b>													
Rated speed	rpm	1333	1000	800	571	400	250	200	160	114	80	57	40
Rated torque	Lb-in	2035	2035	2035	2035	2035	2035	2035	2035	2035	2035	2035	2035
	Nm	230	230	230	230	230	230	230	230	230	230	230	230
Accel torque <sup>(1)</sup>	Lb-in	3540	3540	3540	2655	2655	3540	3540	3540	3540	3540	3540	3540
	Nm	400	400	400	300	300	400	400	400	400	400	400	400
<b>GENERAL DATA</b>													
Inertia <sup>(2)</sup>	Lb-in-s <sup>2</sup> x10 <sup>-4</sup>							132					
	Kg-m <sup>2</sup> x10 <sup>-5</sup>							117					
Max. Backlash	arc-mins	10 or 5											
Efficiency <sup>(3)</sup>	%	96					91						
Rated Life	H						15,000						
Weight	Kg / Lbf	25/56					33/74						
Radial Load <sup>(4)</sup>	N / Lbf						6,000/1350						
Axial Load	N / Lbf						3,000/675						

Note: (1) S5 duty service. (2) On the motorside. (3) Theoretical gear efficiency value.

(4) Load applied in the middle of the output shaft at 300 rpm.

(5) Emergency Stop Torque is 2.5 times Rated Output Torque for 1000 times max during the service life of the gearhead.

# Characteristics of Right Angle Gearheads

MRA 180

No of Stages		1 - Stage					2 - Stages						
Ratio		3	4	5	7	10	16	20	25	35	50	70	100
<b>INPUT</b>													
Rated speed / Max.	rpm	4000 / 6000											
Rated Power	Kw	51	38	31	22	15	10	8	6.3	4.6	3	2.5	1.7
Rated torque	Lb-in	1071	805	646	460	319	212	168	133	97	71	53	35
	Nm	121	91	73	52	36	24	19	15	11	8	6	4
Accel torque <sup>(1)</sup>	Lb-in	1230	920	735	522	363	239	195	159	115	80	62	44
	Nm	138	104	83	59	41	27	22	18	13	9	7	5
<b>OUTPUT</b>													
Rated speed	rpm	1333	1000	800	571	400	250	200	160	114	80	57	40
Rated torque	Lb-in	3097	3097	3097	3097	3097	3097	3097	3097	3097	3097	3097	3097
	Nm	350	350	350	350	350	350	350	350	350	350	350	350
Accel torque <sup>(1)</sup>	Lb-in	5310	5310	5310	5310	5310	5310	5310	5310	5310	5310	5310	5310
	Nm	600	600	600	600	600	600	600	600	600	600	600	600
<b>GENERAL DATA</b>													
Inertia <sup>(2)</sup>	Lb-in-s <sup>2</sup> x10 <sup>-4</sup>												
	Kg-m <sup>2</sup> x10 <sup>-5</sup>												
Max. Backlash	arc-mins	10 or 5											
Efficiency <sup>(3)</sup>	%	96					91						
Rated Life	H	15,000											
Weight	Kg / Lbf	60/134					90/201						
Radial Load <sup>(4)</sup>	N / Lbf	9,000/2023											
Axial Load	N / Lbf	5,000/1124											

Note: (1) S5 duty service. (2) On the motorside. (3) Theoretical gear efficiency value.

(4) Load applied in the middle of the output shaft at 300 rpm.

(5) Emergency Stop Torque is 2.5 times Rated Output Torque for 1000 times max during the service life of the gearhead.



# Right Angle Gearhead Dimensions

**GBSM63-MRA065-XX**

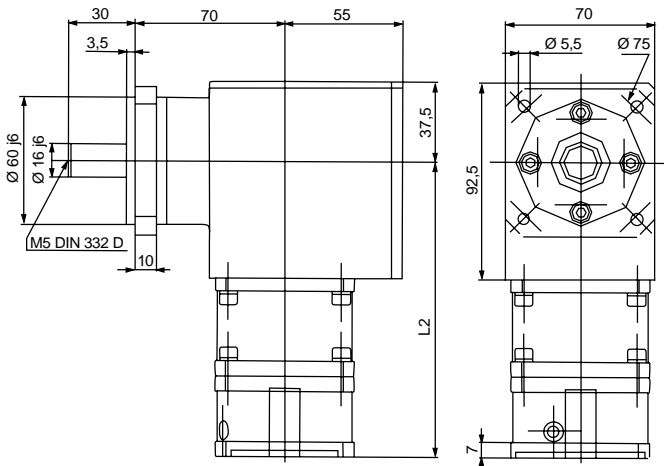

**GBSM80-MRA080-XX**

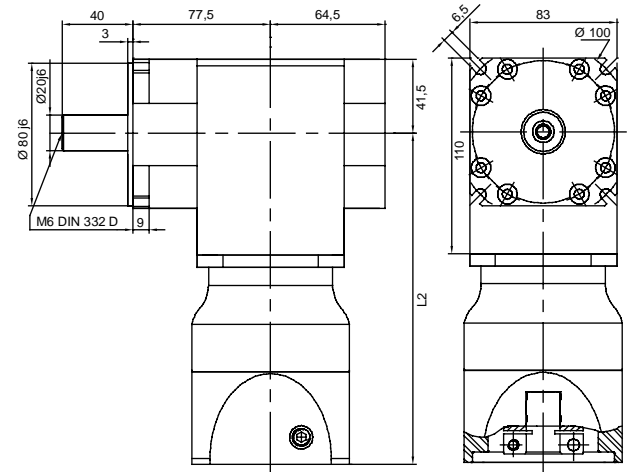

**GBSM90-MRA115-XX**

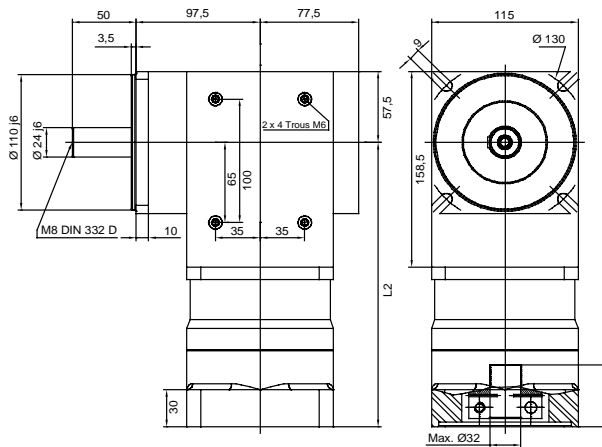

**GBSM100-MRA140-XX**

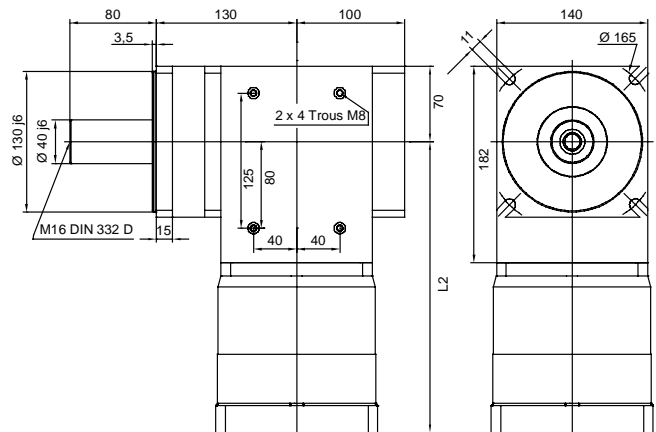

Gear Number	Number of Stages	"L2" Length (mm)
MRA065	1	139
	2	162
MRA080	1	189
	2	204
MRA115	1	231
	2	272
MRA140	1	291
	2	332

Note: "XX" insert specific gear ratios.

Verify that motor torque does not exceed gear rated input torque.

Other BSM and gearhead possibility exist. Contact Baldor with your requirements. Dimensions in mm.

# Stainless Steel Servo Rated Gear Heads - MSS Series

These highly efficient, all stainless steel, all planetary, servo rated gearheads provide low standard backlash of 6 - 15 arc minute maximum over the life of the gearhead. They are designed to mount directly onto Baldor's stainless steel servo motors SSBSM-series.

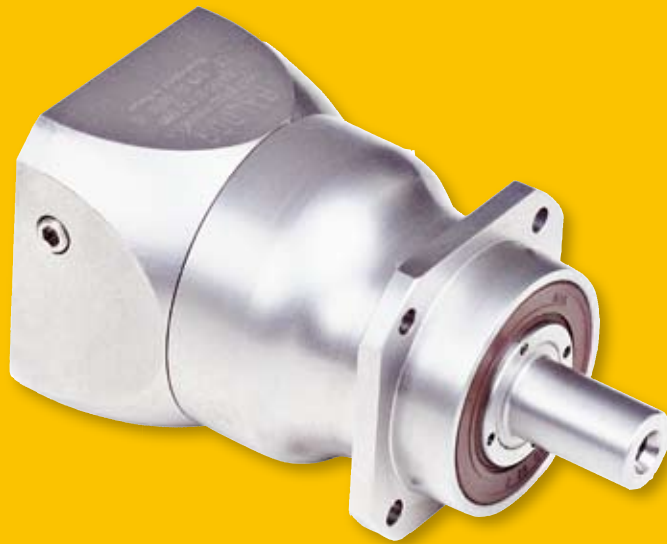

## Stainless Steel Gearhead

- › Backlash of 6-15 arc min for greater positional accuracy
- › Includes an integrated, self-locating, input coupling to make assembly to the motor quick and easy
- › Square mounting flange for motor and output
- › Lubrication - oil - 15 K hours rated load, speed & temperature
- › Satellite gears are hardened, double supported in carrier and rotate on needle bearings
- › Output shaft - stainless steel with Viton™ seal
- › Gearhead housing - all stainless steel
- › Easily cleanable design to handle IP66 and 1,500 psi washdown

# Quick Selection Guide for Stainless Steel MSS Servo Gearheads

MOTOR	SELECTION CHART FOR SSBM C-SERIES AND STAINLESS STEEL GEARHEADS (MSS)													
	BSM Series	1 Stage Ratios					2 Stage Ratios							
		3	4	5	7	10	16	20	25	35	40	50	70	100
80C - 1XX	080	080	080	080	080	080	080	080	080	080	080	080	080	115
80C - 2XX	080	080	080	080	080	080	080	080	080	080	115	115	115	140
80C - 3XX	080	080	080	080	080	080	080	080	080	115	115	115	115	*
80C - 4XX	080	080	080	080	080	080	080	115	115	115	115	140	*	
90C - 1XX	115	115	115	115	115	115	115	115	115	115	115	115	115	140
90C - 2XX	115	115	115	115	115	115	115	115	115	115	115	115	140	*
90C - 3XX	115	115	115	115	115	115	115	115	115	140	140	*	*	
100C - 1XXX	115	115	115	115	115	115	115	115	115	115	115	140	*	
100C - 2XXX	115	115	115	115	115	115	115	115	140	140	140	*	*	
100C - 3XXX	115	115	115	115	115	115	115	140	140	*	*	*	*	
100C - 4XXX	115	115	115	115	140	140	140	140	*	*	*	*	*	
100C - 5XXX	115	115	115	115	140	140	140	*	*	*	*	*	*	
100C - 6XXX	140	140	140	140	140	*	*	*	*	*	*	*	*	

Ordering nonmenclature: for Gearhead only

G BSM80 - MSS080 - 10  
 Gear Motor Gearhead type Ratio

MOTOR	SELECTION CHART FOR SSBM C-SERIES AND STAINLESS STEEL GEARHEADS (MSS)												
	BSM Series	1 Stage Ratios					2 Stage Ratios						
		3	4	5	7	10	16	20	25	35	40	50	70
50N - 1XX	*	*	*	*	*	*	*	*	*	*	*	080	080
50N - 2XX	*	*	*	*	*	*	*	*	*	080	080	080	*
50N - 4XX	*	*	*	*	*	*	*	080	080	080	080	*	*
63N - 1XX	*	*	*	*	*	*	*	*	*	080	080	080	115
63N - 2XX	*	*	*	*	*	*	*	080	080	080	080	115	115
63N - 3XX	*	*	*	*	*	*	080	080	080	080	080	115	115
80N - 1XX	080	080	080	080	080	080	080	080	080	080	080	115	115
80N - 2XX	080	080	080	080	080	080	080	080	115	115	115	115	140
80N - 3XX	080	080	080	080	080	080	080	115	115	115	115	140	*
90N - 1XX	115	115	115	115	115	115	115	115	115	115	115	140	*
90N - 2XX	115	115	115	115	115	115	115	115	140	140	140	*	*
90N - 3XX	115	115	115	115	115	115	115	140	140	*	*	*	*
100C - 1XXX	115	115	115	115	115	115	115	140	140	*	*	*	*
100C - 2XXX	115	115	115	115	140	140	140	140	*	*	*	*	*
100C - 3XXX	115	115	115	140	*	*	*	*	*	*	*	*	*
100C - 4XXX	115	115	115	140	*	*	*	*	*	*	*	*	*

Ordering nonmenclature: for Gearhead only

G BSM80 - MSS080 - 10  
 Gear Motor Gearhead type Ratio

Also Refer to "Quick Selection" in engineering information section.

# Characteristics of Stainless Steel Gearheads

## MSS 080

No of Stages		1 - Stage					2 - Stages							
Ratio		3	4	5	7	10	16	20	25	35	40	50	70	100
<b>INPUT</b>														
Rated speed / Max.	rpm	4000 / 6000												
Rated Power	Kw	12.3	9.2	7.4	4.3	2.2	2.5	1.9	1.6	1.2	0.9	0.8	0.5	0.2
Rated torque	Lb-in	261	196	157	92	46	52	42	33	24	20	17	12	4.4
	Nm	29.5	22.1	17.7	10.4	5.2	5.9	4.7	3.7	2.7	2.3	1.9	1.3	0.5
Accel torque <sup>(1)</sup>	Lb-in	336	257	186	133	71	80	62	53	35	31	27	18	9
	Nm	38	29	21	15	8	9	7	6	4	3.5	3	2	1
<b>OUTPUT</b>														
Rated speed	rpm	1333	1000	800	571	400	250	200	160	114	100	80	57	40
Rated torque	Lb-in	752	752	752	619	442	761	752	752	761	752	752	619	442
	Nm	85	85	85	70	50	86	85	85	86	85	85	70	50
Accel torque <sup>(1)</sup>	Lb-in	973	973	885	885	708	1106	1115	1150	1186	1115	1115	885	708
	Nm	110	110	100	100	80	125	126	130	134	126	126	100	80
<b>GENERAL DATA</b>														
Inertia <sup>(2)</sup>	Lb-in-s <sup>2</sup> x10 <sup>-4</sup>	12.8	12.8	11.8	10.8	10.5	12.2	12.1	11.3	10.6	10.3	12.2	12.2	12.1
	Kg-m <sup>2</sup> x10 <sup>-5</sup>	11.3	11.3	10.4	9.6	9.3	10.8	10.7	10	9.4	9.1	10.8	10.8	10.7
Max. Backlash	arc-mins	10, 5 or 1												
Efficiency <sup>(3)</sup>	%	96					91							
Rated Life	H	15,000												
Weight	Kg / Lbf	3/6.7					4/8.9							
Radial Load <sup>(4)</sup>	N / Lbf	3500/787												
Axial Load	N / Lbf	3000/675												

## MSS 115

No of Stages		1 - Stage					2 - Stages							
Ratio		3	4	5	7	10	16	20	25	35	40	50	70	100
<b>INPUT</b>														
Rated speed / Max.	rpm	4000 / 6000												
Rated Power	Kw	31.4	31.4	22.2	12.6	6.3	8.3	6.7	5	3.8	2.5	2.1	1.7	1.4
Rated torque	Lb-in	796	619	442	265	133	177	142	106	80	62	53	35	18
	Nm	90	70	50	30	15	20	16	12	9	7	6	4	2
Accel torque <sup>(1)</sup>	Lb-in	920	717	496	327	186	204	186	150	115	80	71	44	27
	Nm	104	81	56	37	21	23	21	17	13	9	8	5	3
<b>OUTPUT</b>														
Rated speed	rpm	1333	1000	800	571	400	250	200	160	114	100	82	57	40
Rated torque	Lb-in	2390	2390	2115	1673	1195	2390	2390	2257	2372	2257	2265	2265	1593
	Nm	270	270	239	189	135	270	270	255	268	255	256	256	180
Accel torque <sup>(1)</sup>	Lb-in	2708	2743	2390	2212	1770	3009	3380	3407	3451	2743	2743	2832	2390
	Nm	306	310	270	250	200	340	382	385	390	310	310	320	270
<b>GENERAL DATA</b>														
Inertia <sup>(2)</sup>	Lb-in-s <sup>2</sup> x10 <sup>-4</sup>	50.2	50.2	45.7	41.6	39.7	47.8	47	44	41	39.2	47.6	47.6	47.3
	Kg-m <sup>2</sup> x10 <sup>-5</sup>	44.4	44.4	40.4	36.8	35.1	42.3	42	38.9	36	34.7	42.1	42.1	41.9
Max. Backlash	arc-mins	10, 5 or 1												
Efficiency <sup>(3)</sup>	%	96					91							
Rated Life	H	15,000												
Weight	Kg / Lbf	7.5/16.5					9/20							
Radial Load <sup>(4)</sup>	N / Lbf	5500/1237												
Axial Load	N / Lbf	5000/1124												

Note: (1) S5 duty service. (2) On the motorside. (3) Theoretical gear efficiency value.

(4) Load applied in the middle of the output shaft at 300 rpm.

(5) Emergency Stop Torque is 2.5 times Rated Output Torque for 1000 times max during the service life of the gearhead.

### MSS 140

No of Stages		1 - Stage					2 - Stages							
Ratio		3	4	5	7	10	16	20	25	35	40	50	70	100
INPUT														
Rated speed / Max.	rpm	4000 / 6000												
Rated Power	Kw	41.9	41.9	40.1	22.9	11.3	12.1	12.1	9.6	6.7	4.6	3.4	2.9	2.5
Rated torque	Lb-in	1106	885	850	487	239	257	257	204	142	106	88	53	27
	Nm	125	100	96	55	27	29	29	23	16	12	10	6	3
Accel torque <sup>(1)</sup>	Lb-in	1531	1150	920	655	363	301	274	221	150	133	106	71	35
	Nm	173	130	104	74	41	34	31	25	17	15	12	8	4
OUTPUT														
Rated speed	rpm	1333	1000	800	571	400	250	200	160	114	100	82	57	40
Rated torque	Lb-in	3186	3398	3982	3265	2292	3487	4363	4327	4212	3982	3982	3363	2416
	Nm	360	348	450	369	259	394	493	489	476	450	450	380	273
Accel torque <sup>(1)</sup>	Lb-in	4425	4425	4425	4425	3540	4425	4956	4956	4780	5832	4867	4425	3486
	Nm	500	500	500	500	400	500	560	560	540	546	550	500	360
GENERAL DATA														
Inertia <sup>(2)</sup>	Lb-in-s <sup>2</sup> x10 <sup>-4</sup>	107	101	97	87	81	103	103	96	90	85	79	79	79
	Kg-m <sup>2</sup> x10 <sup>-5</sup>	95	89	86	77	72	91	91	85	80	75	70	70	70
Max. Backlash	arc-mins	10, 5 or 1												
Efficiency <sup>(3)</sup>	%	96					91							
Rated Life	H	15,000												
Weight	Kg / Lbf	9/20					17/38							
Radial Load <sup>(4)</sup>	N / Lbf	9100/2046												
Axial Load	N / Lbf	9100/2046												

Note: (1) S5 duty service. (2) On the motorside. (3) Theoretical gear efficiency value.

(4) Load applied in the middle of the output shaft at 300 rpm.

(5) Emergency Stop Torque is 2.5 times Rated Output Torque for 1000 times max during the service life of the gearhead.

## Stainless Steel Gearhead Dimensions

### MSS080

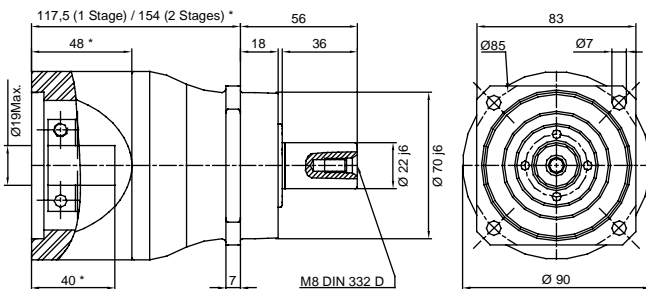

### MSS115

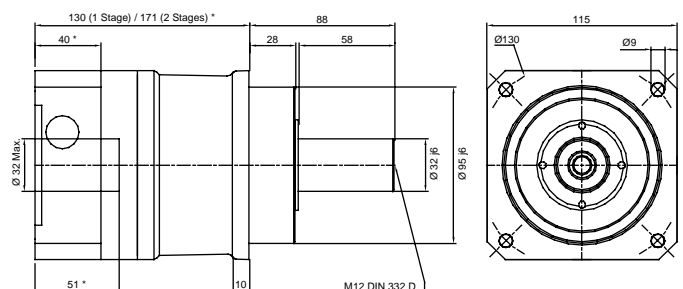

### MSS140

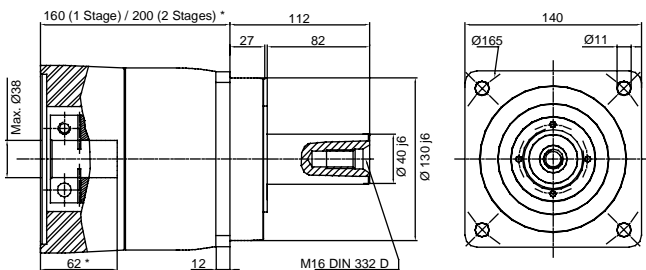

Gear Number	Number of Stages	"L2" Length (mm)
MSS080	1	117.5
	2	154
MSS115	1	130
	2	171
MSS140	1	160
	2	200

Note: "XX" insert specific gear ratios.

Verify that motor torque does not exceed gear rated input torque.

Other BSM and gearhead possibility exist. Contact Baldor with your requirements. Dimensions in mm.

# Engineering Information

- › Brushless motor ID matrix for BSM N and C series
- › Brushless motor ID matrix for BSM25 and 33Series
- › Speed torque curves
- › How to interpret motor Information
- › Thrust and radial load
- › Motor connection diagrams
- › BSM mating connectors
- › Resolver specifications
- › Encoder specifications
- › Brake data for BSM and SSBSM
- › Servo motor selection
- › Servo motor requirement sheet
- › Quick selection of planetary gearheads
- › Conversion tables



# Brushless Servo Motor Identification Matrix

## N and C Series

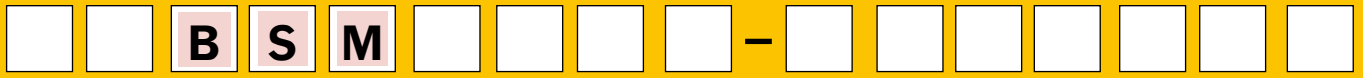

Blank = Std

SS = Stainless Steel

Note: Not all options are available on all motors. Contact your local Baldor District Office.

**Frame**

IEC	NEMA
50	5N
63	6N
80	8N
90	9N
100	10 N
132	

**Series**

N  
C

**Motor Size**

1  
2  
3  
4

**Winding Code**

50  
75  
etc.

**Motor Options**

Description	Connections				
	Standard (Metric) Threaded Style	Optional (Inch) Quick Connect	Cables (5)	Flying Leads (5)	Rotate-able (Metric) Threaded (9)
Motor (No Shaft Seal)	A	I	E	M	R
Motor & Brake	B	J	F	N	S
Motor with Shaft Oil Seal	C	K	G	O	T
Motor with Brake & Shaft Oil Seal	D	L	H	P	U

**Feedback Options**

- A = Resolver
- B = Absolute Encoder – Single-Turn (BiSS)
- B2 = Absolute Encoder – Multi-turn (BiSS)
- D = Absolute Encoder – Multi-turn (EnDat)
- D2 = Absolute Encoder – Single-turn (EnDat)
- D3 = Absolute Encoder – Single-turn (Hyperface)
- D4 = Absolute Encoder – Multi-turn (Hyperface)
- S1 = Absolute Encoder – Single-turn (SSI)
- S2 = Absolute Encoder – Multi-turn (SSI)
- E = Incremental Encoder w/Commutation (1000 ppr)
- F = Incremental Encoder w/Commutation (2500 ppr)
- H = Halls only
- V = Encoder mounting only
- Y = Resolver mounting only

**Accessory Options**

- Blank = No Option
- M = No Keyway
- N = DIN 42955-R
- O = DIN 42955-R & No Keyway
- P = Optional Motor Connector on BSM 90  
(Note: This option available only if current less than 20 amps)
- X = Special Option (order by spec no. only)
- Z1 = Blower (115 VAC) (not available on all motors)
- Z2 = Blower (230 VAC) (not available on all motors)
- Z3 = Blower (24 VDC)
- Z4 = Blower (230/460 VAC) for BSM132 only.

- NOTE:**
- 1) The standard BSM50/63/80 Series includes feedback, two threaded connectors for feedback and motor terminations, square mounting flange.
  - 2) The standard BSM90/100 Series includes feedback, one threaded connector for feedback termination, termination of motor lead wires on terminal block, square mounting flange.
  - 3) BSM Motors do not have shaft seal as standard. BSM motors are IP60. Motors with meet IP65 with shaft oil seal.
  - 4) SSBSM motors available with IEC mounting and include as standard a shaft seal. SSBSM motors are IP67.

- 5) The standard BSM50 Series has as standard no keyway.
- 6) Shielded cables and flying leads are one meter long as standard.
- 7) Order motor power and feedback cable assemblies as separate items.
- 8) Motors may be used with 115/230/400/460 volt controls. Verify that maximum speed is not exceeded.
- 9) Pricing for NEMA versions 5N, 6N, 8N, and 9N same as 50, 63, 80, and 90.
- 10) Contact Baldor for special options.



# Brushless Motor Identification Matrix for 25 and 33 Series

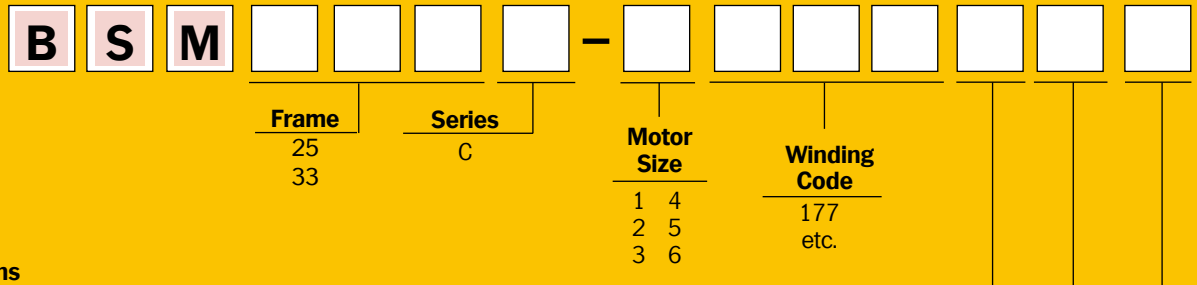

**Motor Options**

Description	Connections	
	Flying Leads	Rotatable Feedback Connector & Motor Terminal Box
Motor (No Shaft Seal)	M	R
Motor & Brake	N	S
Motor with Shaft Oil Seal	O	T
Motor with Brake & Shaft Oil Seal	P	U

**Feedback Options**

- H = Halls
- A = Resolver
- E = Incremental Encoder w/Commutation (1000 ppr)
- F = Incremental Encoder w/Commutation (2500 ppr)

**Accessory Options**

- Q = Foot & Round Face
- C = Round Face Only
- F = Foot Mount
- C1 = 33 Frame Only IEC Flange MTG
- C2 = 33 Frame Only IEC Face MTG

# Speed – Torque Curves

## How to Read Motor Performance Curves

Baldor has provided the following curves in order to simplify the process of selecting both a motor and control for a specific application. The following paragraphs explain how the information in these curves should be interpreted.

In constant speed applications, motors are defined in terms of horsepower or kilowatts (which is torque at a base speed). Servo motors normally operate over a wide speed range. The curves show continuous torque (defined as torque which will not overheat the motor), and peak torque (defined as intermittent acceleration torque).

It is also necessary to know the current and voltage required for the motor to operate. The curves have a scale that shows current required for any torque, and voltage required for any speed.

As an example, an application requires a continuous torque of 25 lb-in (2.8 Nm) at a speed of 1000 RPM. The peak torque required for acceleration is 80 lb-in (9 Nm).

This curve shows that the motor will work in this application. The bus voltage required is 320VDC. The continuous and peak currents required is 3.5 and 12 amps.

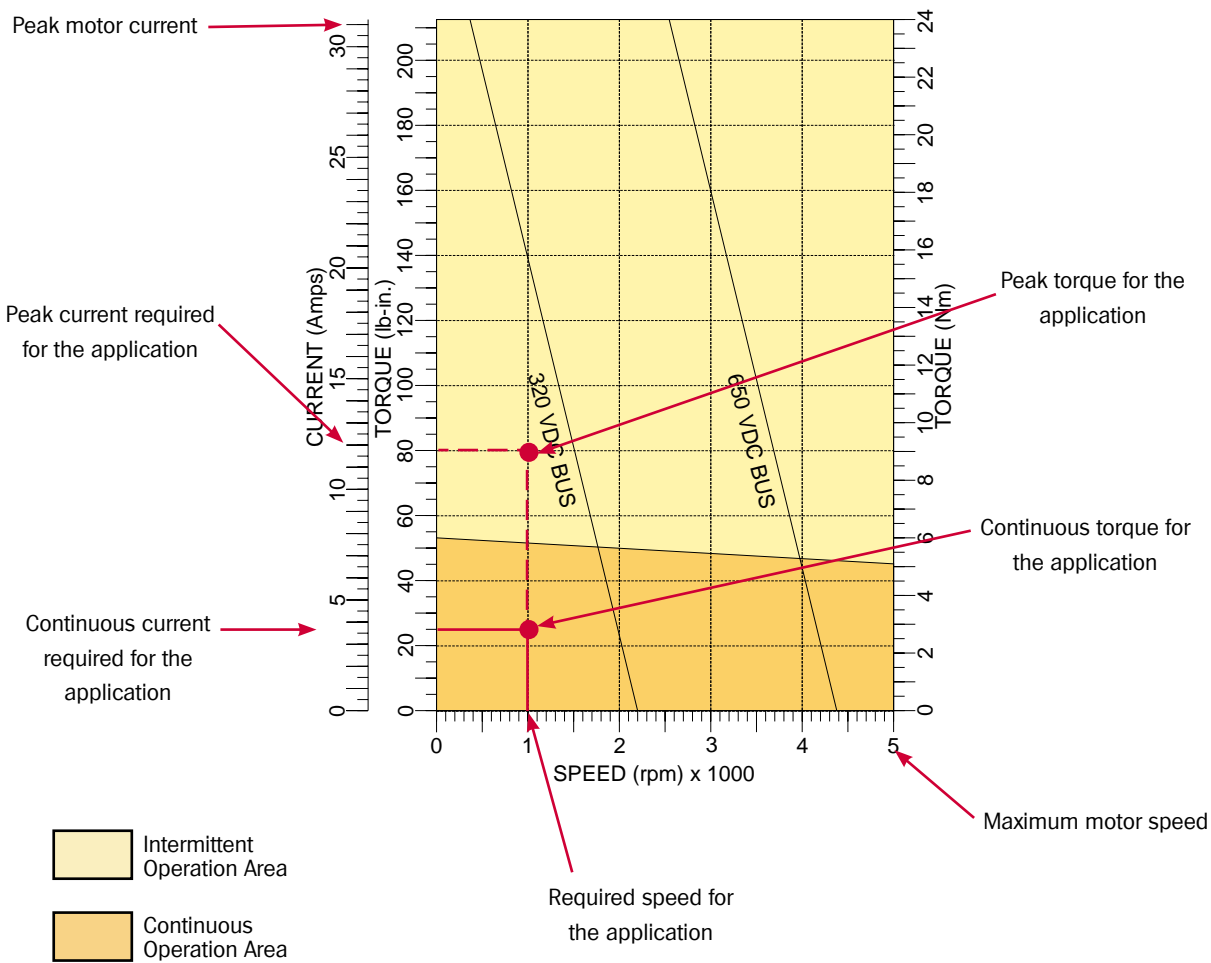

Baldor has provided the fl

# How to Interpret Motor Information

## “Rated” Voltage/Speed

“Rated” conditions refer to measurement points, and are selected as an easy and convenient “reference” or “measurement” point. Manufacturers select a “rated voltage”, operate with a “rated torque”, to verify that “rated speed” is reached.

Note that any voltage may be applied to Baldor motors. Thus, with the BSM series of brushless servo motors, either 160 VDC, 300 VDC, or 650 VDC may be applied. However the design limits must be observed. And those are: 1) maximum speed (rpm) limit, 2) demagnetization (max torque/current) limit, and 3) 650 VDC maximum.

## Motor Data

All Baldor BSM motors are 3-phase WYE connected. Connection is important because the motor/feedback is phase sensitive. All motor parameters are expressed as phase to phase (line-to-line) figures. This includes voltage constant, resistance and inductance.

The phase to phase voltage constant (back-emf) is a sinusoidal wave, which is measured while driving the motor (as a generator) at 1000 rpm, and measuring the output voltage. The peak of this measured output voltage is shown in the literature as  $V_{pk}/krpm$ ; the RMS of the output voltage is  $V_{rms}/krpm$ .

Some data in the motor tables are expressed as “cold” figures (25°C), while others are “hot” (155°C) values. The cold figures are: voltage constant, torque constant, resistance, inductance, peak torque and peak current. The hot figures are: continuous stall torque and continuous stall current.

The temperature coefficient between cold and hot voltage constant (and torque constant) is 0.90 for N-series, 0.80 for C-series and 0.85 for BSM132 series. Motor resistance changes by a factor of 1.5 from 25°C to 155°C.

## Motor Temperature

The BSM series of servo motors are rated for a maximum continuous winding temperature of 155°C. These conditions are plotted in a 25°C ambient on the motor speed-torque curves. For operation at 40°C ambient derate by 6%.

The temperature rise of the motor windings depends upon the amount of torque which is being delivered to the load. In this brochure, the thermal limit line (line dividing dark and light shaded areas on the speed-torque curves) indicates the 155°C limit.

Temperature range - normal operating range of bearing grease is - 29°C to 155°C.

Altitude - the motors are rated for operation at 1000m or lower; derate 10% per 1000m.

The BSM motors include an internal thermal switch (bi-metallic) which is normally closed. It opens at 155°C  $\pm$ 5°. This switch may be connected to the input of a motion controller, programmable logic device, or other type of machine control. Any of these devices could then sense this switch and shut power down when the thermal switch opens.

# AC Servo Motors

## Thrust Load Capacity

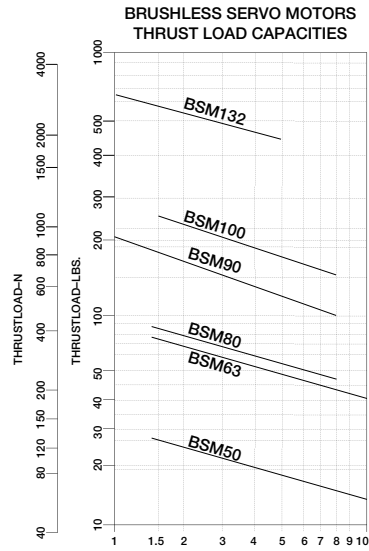

## Radial Load Capacity

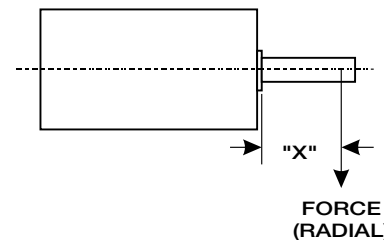
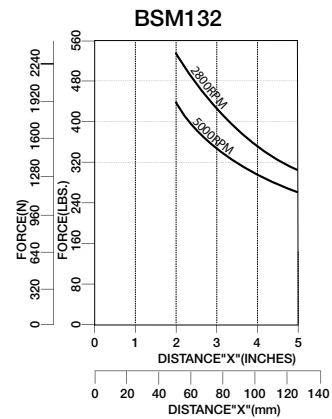
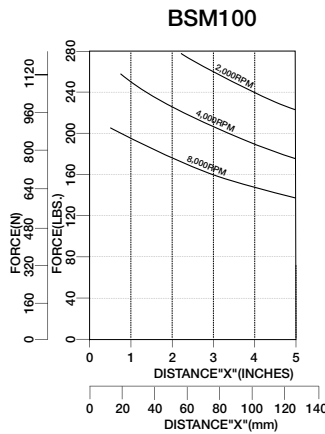
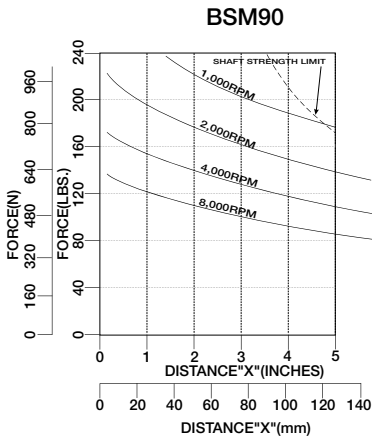
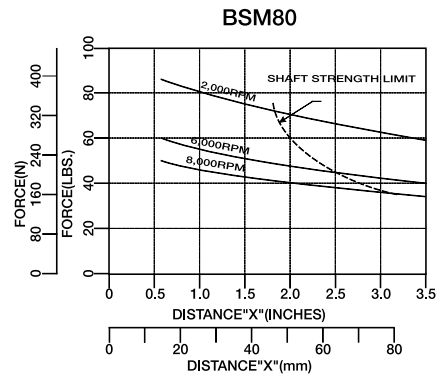
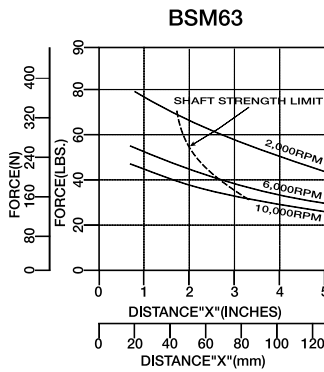
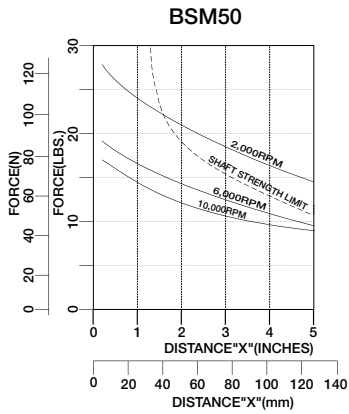

**NOTES:**

- 1) Solid lines are based on  $L_{104} = 20,000$  hours.
- 2) Dashed line is based on  $10^7$  load peaks @ 110% of rated torque.

# Motor Connection Diagrams

## Motor-Resolver BSMxxx-xxxxA

## Motor-Encoder BSMxxx-xxxxF or E

### Terminal Block

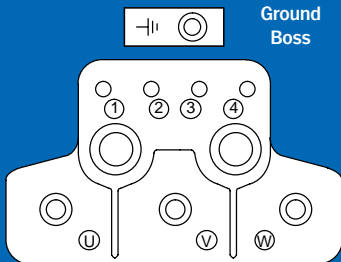

### Power Connections BSM 90/100

Post	Function
1	Thermal Switch
2	Thermal Switch
3	Brake (optional)
4	Brake (optional)
U1	Motor Lead U
V2	Motor Lead V
W3	Motor Lead W
SCREW	Ground

### Terminal Block

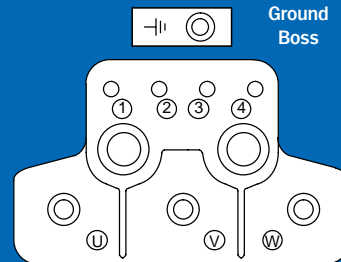

### Power Connections BSM 90/100

Post	Function
1	Thermal Switch
2	Thermal Switch
3	Brake (optional)
4	Brake (optional)
U1	Motor Lead U
V2	Motor Lead V
W3	Motor Lead W
SCREW	Ground

### Standard Motor Connector

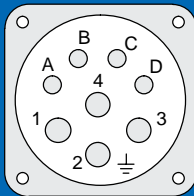

### Power Connections BSM 50/63/80 and SSBSM

Post	Function
A	Thermal Switch
B	Thermal Switch
C	Brake (optional)
D	Brake (optional)
1	Motor Lead U
2	Ground
3	Motor Lead W
4	Motor Lead V

### Standard Motor Connector

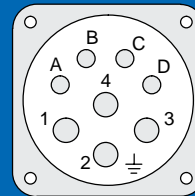

### Power Connections BSM 50/63/80 and SSBSM

Post	Function
A	Thermal Switch
B	Thermal Switch
C	Brake (optional)
D	Brake (optional)
1	Motor Lead U
2	Ground
3	Motor Lead W
4	Motor Lead V

### Standard Resolver Connector

12 Pin

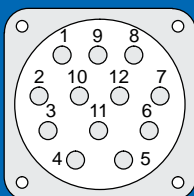

### Resolver Connections BSM and SSBSM

Post	Function
1	REF HI R1
2	REF LO R2
3	COS+ S1
4	COS- S3
5	SINE+ S2
6	SINE- S4
7-12	No Connection

### Standard Encoder Connector

16 Pin

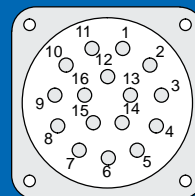

### Encoder Connections BSM and SSBSM

Post	Function
1	DC + 5V
2	Ground
3	Channel A
4	Channel A
5	Channel B
6	Channel B
7	Channel Z
8	Channel Z
9	Open
10	Channel U
11	Channel U
12	Channel V
13	Channel V
14	Channel W
15	Channel W
16	No Connection

Note: For BSM 50/63/80 (and option on BSM90), the power connector is rated at 25 amps.

# Motor Connection Diagrams

## Motor-BiSS BSMxxx-xxxxB or B2

## Motor-EnDat BSMxxx-xxxxD2 or D

### Terminal Block

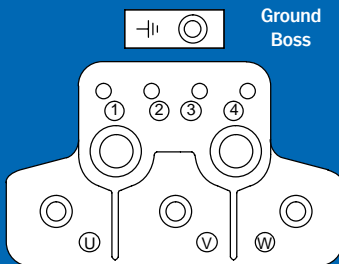

### Power Connections BSM 90/100

Post	Function
1	Thermal Switch
2	Thermal Switch
3	Brake (optional)
4	Brake (optional)
U1	Motor Lead U
V2	Motor Lead V
W3	Motor Lead W
SCREW	Ground

### Terminal Block

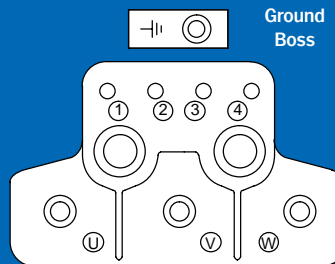

### Power Connections BSM 90/100

Post	Function
1	Thermal Switch
2	Thermal Switch
3	Brake (optional)
4	Brake (optional)
U1	Motor Lead U
V2	Motor Lead V
W3	Motor Lead W
SCREW	Ground

### Standard Motor Connector

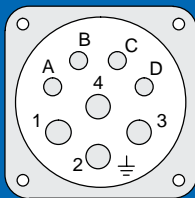

### Power Connections BSM 50/63/80 and SSBSM

Post	Function
A	Thermal Switch
B	Thermal Switch
C	Brake (optional)
D	Brake (optional)
1	Motor Lead U
2	Ground
3	Motor Lead W
4	Motor Lead V

### Standard Motor Connector

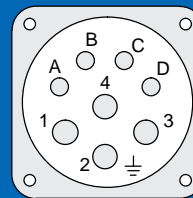

### Power Connections BSM 50/63/80 and SSBSM

Post	Function
A	Thermal Switch
B	Thermal Switch
C	Brake (optional)
D	Brake (optional)
1	Motor Lead U
2	Ground
3	Motor Lead W
4	Motor Lead V

### Standard BiSS Connector

12 Pin

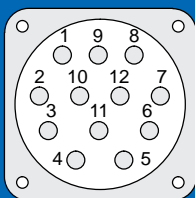

### BiSS Connections BSM and SSBSM

Post	Function
1	DATA-
2	A+ (SIN+)
3	OV Sensor
4	B+ (COS+)
5	Clock-
6	-
7	Clock+
8	B- (COS-)
9	5V & Up Sense
10	OV DGND
11	A- (SIN-)
12	DATA+

### Standard EnDat Connector

12 Pin

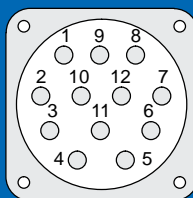

### EnDat Connections BSM and SSBSM

Post	Function
1	DATA-
2	SIN A+
3	OV Sensor
4	COS B+
5	Clock -
6	5V Sensor
7	Clock +
8	COS B-
9	+5V
10	DGND
11	SIN A-
12	DATA+

Note: For BSM 50/63/80 (and option on BSM90), the power connector is rated at 25 amps.

# Motor Connection Diagrams

## Motor-SSI BSMxxx-xxxxS1 or S2

## Motor-Hyperface BSMxxx-xxxxD3 or D4

### Terminal Block

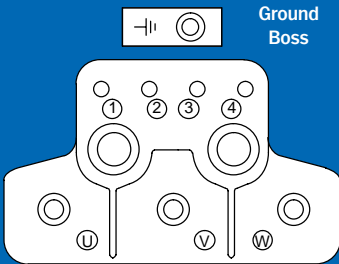

### Power Connections BSM 90/100

Post	Function
1	Thermal Switch
2	Thermal Switch
3	Brake (optional)
4	Brake (optional)
U1	Motor Lead U
V2	Motor Lead V
W3	Motor Lead W
SCREW	Ground

### Terminal Block

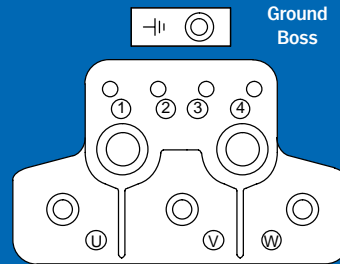

### Power Connections BSM 90/100

Post	Function
1	Thermal Switch
2	Thermal Switch
3	Brake (optional)
4	Brake (optional)
U1	Motor Lead U
V2	Motor Lead V
W3	Motor Lead W
SCREW	Ground

### Standard Motor Connector

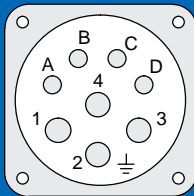

### Power Connections BSM 50/63/80 and SSBSM

Post	Function
A	Thermal Switch
B	Thermal Switch
C	Brake (optional)
D	Brake (optional)
1	Motor Lead U
2	Ground
3	Motor Lead W
4	Motor Lead V

### Standard Motor Connector

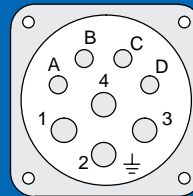

### Power Connections BSM 50/63/80 and SSBSM

Post	Function
A	Thermal Switch
B	Thermal Switch
C	Brake (optional)
D	Brake (optional)
1	Motor Lead U
2	Ground
3	Motor Lead W
4	Motor Lead V

### Standard SSI Connector

12 Pin

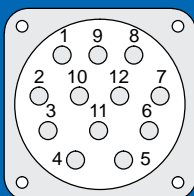

### SSI Connections BSM and SSBSM

Post	Function
1	+Vs (5VDC)
2	0V
3	SSI Clock
4	NSSI Clock
5	SSI DATA
6	NSSI DATA
7	-
8	-
9	Connected to Pin 1
10	-
11	-
12	-

### Standard Hyperface Connector

12 Pin

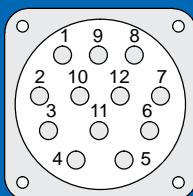

### Hyperface Connections BSM and SSBSM

Post	Function
1	DATA-
2	+SIN
3	Open
4	+COS
5	OPEN
6	OPEN
7	OPEN
8	REFCOS
9	US 7-12V
10	GND
11	REFSIN
12	DATA+

Note: For BSM 50/63/80 (and option on BSM90), the power connector is rated at 25 amps.



# Motor Connection Diagrams

## Motor – Halls BSM25C–xxxxMHx

### Flying Leads Power Connections BSM25C

Wire Color	Function
1 (T1)	U
2 (T2)	V
3 (T3)	W
Green/Yellow	Ground

### Flying Leads Hall Connections BSM25C

Wire Color	Function
White	S1 Hall Switch
Yellow	S2 Hall Switch
Orange	S3 Hall Switch
Red	VCC+
Black	Ground

## Motor – Halls BSM33C–xxxxMHx

### Flying Leads Power Connections BSM33C

Wire Color	Function
Yellow or Blue	Thermal Switch*
Yellow or Blue	Thermal Switch*
Black	U
Red	V
Blue	W
Green/Yellow	Ground

\*When Required

### Flying Leads Hall Connections BSM33C

Wire Color	Function
Blue	S1 Hall Switch (U+)
Brown	S2 Hall Switch (V+)
Blue/White	S3 Hall Switch (W+)
Red	VCC+
Black	Ground

# Feedback Specifications

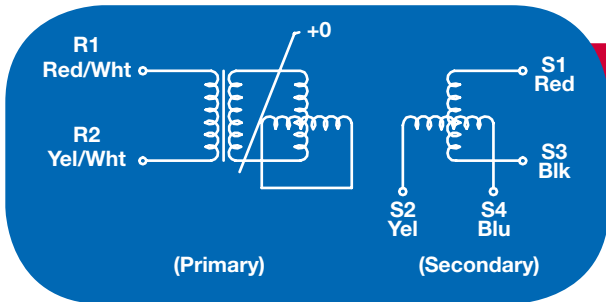

## Resolver Specifications

Power Source		AC 10Vrms
Primary Element		Rotor
Electrical Error		±7
Resolver Speed		1
Transformation Ratio		0.5±10%
Phase Shift		+ 8° Nominal
Accuracy Spread		12 Arc Minutes
Input Impedance	ZRO	90 + i180 Nominal
Output Impedance	ZSO	220 + i350 Nominal at 0° (S1-S3)
	ZSS	210 + i300 Nominal at 0° (S1-S3)
D.C. Resistance	ROTOR	46 Ref
	STATOR	120 Ref
Dielectric Strength		AC500 Volts 1 Minute 60 (50) Hz
Insulation Resistance		100 M Min DC 500 Volts
Weight		0.18 kg Max
Max Operating Speed		10,000 Min
Operating Temperature Range		-55° C to +150° C
Output Equation		ES1 - S3 KE R1-R2 COS
		ES2 - S4 KE R1-R2 SIN

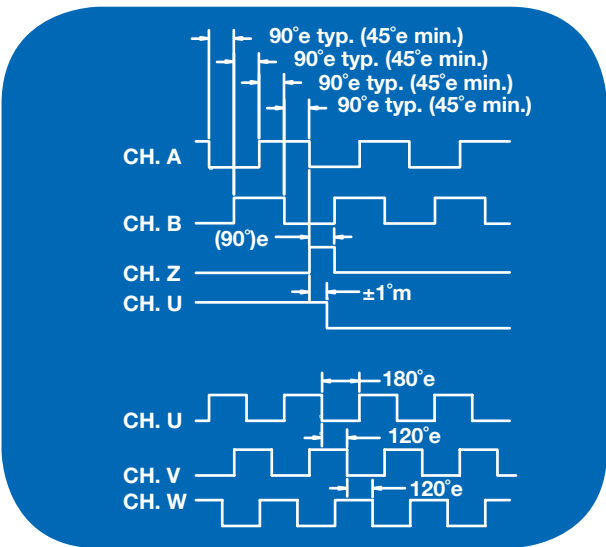

## Encoder Specifications

Power In	5V
Output	Line Driver
	Incremental 2 Channel
	Index
PPR	Hall Output (4 or 8 pole)
	STD 2500 ppr
Hall Output	Contact Baldor for other options
	BSM/SSBSM 50/63/80 series use 4 pole Hall output. 90/100 series use 8 pole Hall output.

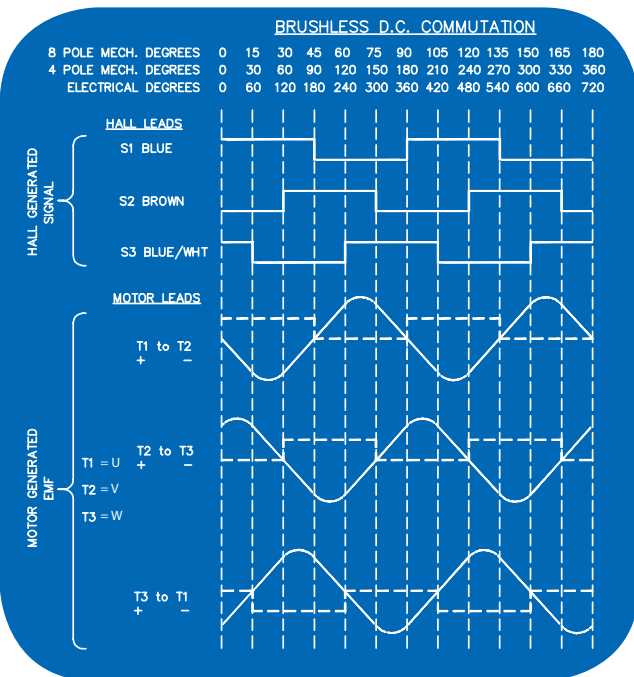

## Hall Sensor Specs

Power In	3.8–30 VDC
Output	Hall Output (4 or 8 pole)

# Motor Mating Connectors

100

Termination	Motor Type	Description	Number
Motor Power	BSM50/63/80/90/100	Mate Assy Power CE Threaded Connector (25 amp) (8 pin)	MCSPOW-08
	BSM132	Mate Assy Rotatable Power (70 amp)	C/F
	SSBSM	Mate Assy Power Stainless Steel Threaded Conn (25 amp)	MCSPOW-08S
Strain Relief	BSM90/100	PG21 Strain Relief	MCS-PG21
		PG29 Strain Relief	ASR24661
		Adaptor (PG29 to PG21)	ASR24662
		M40 Strain Relief	MCS-M40
		Adaptor (M40 to M25)	MCS-M40A
Resolver, BiSS, SSI, Hyperface, EnDat	BSM50/63/80/90/100/132	Mate Assy Feedback CE Threaded Connector (12 pin)	MCSRES-12
	SSBSM	Mate Assy Feedback Threaded Conn Stainless Steel	MCSRES-12S
	BSM - F-Series	F-Series Resolver Mate Assy (14 pin)	MSCN
Encoder	BSM50/63/80/90/100/132	Mate Assy Encoder CE Threaded Connector (16 pin)	MCSENC-16
	SSBSM	Mate Assy Encoder Threaded Conn Stainless Steel	MCSENC-16S

Note: BSM/SSBSM 50/63/80 series require both power and feedback cables. Refer to BR1202-H for cable assemblies.

## Flange Adaptor Kits

Order Number	Description
2R-BSM63	Kit for BSM63A to convert to old equivalent 2R mounting [thickness = 0.416 inch (10.5mm)]
3R-BSM80	Kit for BSM80A to convert to old equivalent 3R mounting [thickness = 0.561 inch (14.2mm)]
4R-BSM90	Kit for BSM90A to convert to old equivalent 4R mounting [thickness = 0.804 inch (20.4mm)]
56-BSM90	Kit for BSM90A to convert to 56 mounting [thickness = 0.952 inch (24mm)]
6R-BSM100	Kit for BSM100A to convert to old equivalent 6R mounting [thickness = 0.647 inch (16.4mm)]

Note: The standard shaft extension will be reduced by the thickness of the above kit adapter flange. If desired, a custom motor may be ordered with shaft length appropriate for mounting.  
Dimensions are nominal.

# Brake Data for BSM and SSBSM

Motor Code	Brake Holding Torque Nm (lb-in)	Watts	Brake Voltage	Brake Current (amps)	Brake Times (msec)		Brake Inertia	
					Set	Release	(lb-in-s <sup>2</sup> )	(Kg-cm <sup>2</sup> )
BSM50N	1.1 (10)	10.1	24	0.5	3	20	0.000017	0.019
BSM63N	2 (18)	11.9	24	0.6	6	43	0.000016	0.018
BSM80	4.5 (40)	19.7	24	0.7	9	48	0.000111	0.125
BSM90	15.8 (140)	22.5	24	0.9	14	110	0.00016	0.181
BSM100	39.5 (350)	33.7	24	1.4	22	195	0.00064	0.723
BSM25C	1.7 (15)	10	24	0.4	16	27	0.00003	0.034
BSM33C	15.8 (140)	22	24	0.9	14	110	0.00016	0.181

Note: All standard brakes used on Baldor BSM motors are 24VDC. The application needs to provide this voltage to release the brake. The brake is a safety brake only and not intended to be used to decelerate loads. Special consideration should be taken when mounting brake/encoder motors in vertical position. Contact Baldor for details.  
Detailed engineering drawings are available upon request.

# Servo Motor Selection

## › Calculating Servo Motor Requirements

In selecting a motion control package, one of the areas requiring identification is the mechanics of the load which will be moved. Once this physical data is obtained, the proper matching of motor and control can easily begin.

The mechanics of the load involve both friction (which is easy to understand) and inertia (which is an unknown, since we have difficulty in recalling the physics we had in school).

The first part of the equation, determining friction of the load, can be accomplished by either estimating, or measuring by simply using a torque wrench.

The second part is determining the inertia. Inertia is the resistance of an object to be accelerated, or decelerated. In motion control, inertia is an important parameter since it defines the torque required to accelerate the load and get it into position.

If no one has told you what the inertia is, then to answer this question, you will have to do a calculation. However, once sufficient information is obtained, the task is relatively simple.

To determine the inertia, the mechanical linkage system which will be moved will be analyzed. These mechanical systems can be divided into four basic categories: direct drive, gear drive, tangential drive, and ballscrew drive.

In the following, each of these mechanical linkage categories and relevant formulas for calculating the load parameters will be presented. In all instances, the formulas reflect the load parameters as “seen” by the motor. Reflecting all these parameters back to the motor shaft make the calculation easier for selecting the motor and control for your motion control application.

## › Direct Drive

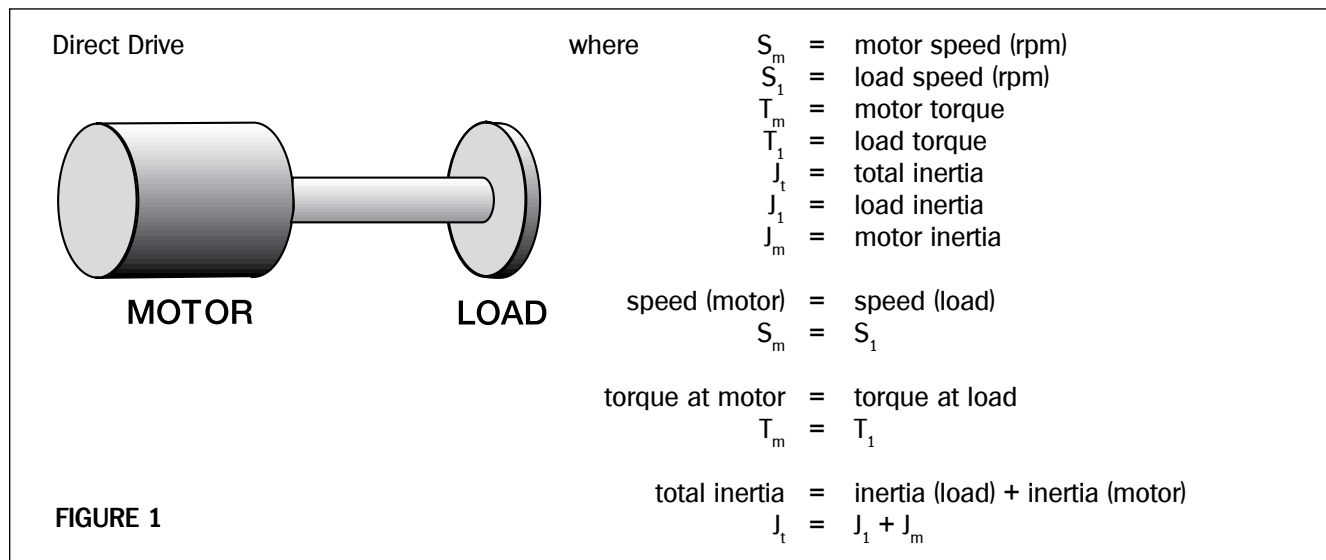

The simplest of packages is the first basic category, the direct drive. This would not require the load parameters to be reflected back, since there are no mechanical linkages involved.

The equations for the direct drive are presented in Figure 1. The speed of the load is the same as the motor, the friction of the load is the friction which the motor must overcome, and the load inertia is directly what the motor would “see”.

## › Inertia

Solid Cylinder:

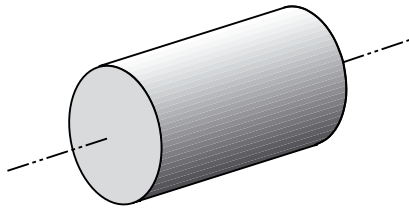

where

- J = inertia
- W = weight
- R = radius
- g = gravitational constant (386 in/s<sup>2</sup>)(980 cm/s<sup>2</sup>)
- L = length
- p = density

For a known weight and radius:

$$J = \frac{1}{2} \frac{W R^2}{g}$$

For a known density, radius, and length:

$$J = \frac{1}{2} \frac{\pi L p R^4}{g}$$

Hollow Cylinder:

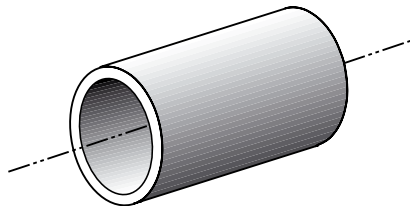

where

- J = inertia
- W = weight
- Ro = outer radius
- Ri = inner radius
- g = gravitational constant (386 in/s<sup>2</sup>)(980 cm/s<sup>2</sup>)
- L = length
- p = density

For a known weight and radius

$$J = \frac{1}{2} \frac{W}{g} (R_o^2 + R_i^2)$$

For a known density, radius, and length:

$$J = \frac{1}{2} \frac{\pi L p}{g} (R_o^4 - R_i^4)$$

FIGURE 2

Material	Density (lb/in <sup>3</sup> )	gm/cm <sup>3</sup>
aluminum	.098	2.72
copper	.322	8.91
plastic	.040	1.11
steel	.280	7.78
wood	.029	0.8

Inertia can be calculated if either the weight and radius are known; or the density, radius, and length are known. Figure 2 presents the equations.

As an example, if the cylinder were a lead screw with a radius of .312 inches (0.79 cm) and a length of 22 inches (55.8 cm), then the inertia would be:

$$J = \frac{1}{2} \frac{\pi L p R^4}{g} = \frac{1}{2} \frac{\pi (22) (.28) (.312)^4}{386} = 0.000237 \text{ lb-in-s}^2$$

$$\text{Metric} = \frac{1}{2} \frac{\pi (55.8) (7.75) (0.79)^4}{980} = 0.26 \text{ gm-cm-s}^2$$

These equations are important since the inertia of mechanical components (i.e. shafts, gears, drive rollers, leadscrews, etc.) can be calculated by using them. Once the inertia is determined, it becomes just a task of reflecting that load inertia and friction through the mechanical linkages to what the motor will “see”.

## › Gear Drive

104

Gear Drive:

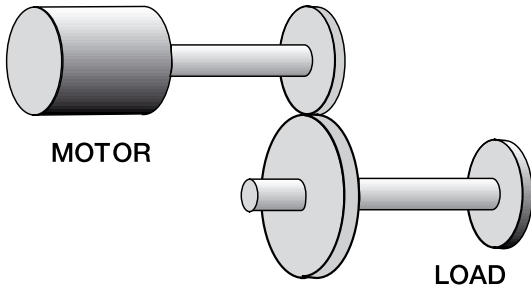

where

$S_m$  = motor speed (rpm)  
 $S_1$  = load speed (rpm)  
 $N$  = gear ratio  
 $N_1$  = number of load gear teeth  
 $N_m$  = number of motor gear teeth  
 $T_m$  = motor torque  
 $T_1$  = load torque  
 $e$  = efficiency  
 $J_t$  = total inertia  
 $J_1$  = load inertia  
 $J_m$  = motor inertia

speed (motor) = speed (load) x gear ratio

$$S_m = S_1 \times N$$

$$\text{or } S_m = S_1 \times N_1 \div N_m$$

torque at motor = torque at load ÷ gear ratio

$$T_m = \frac{T_1}{N}$$

total inertia = inertia (load) ÷ (gear ratio<sup>2</sup>) + inertia (motor)

$$J_t = \frac{J_1}{N^2} + J_m$$

FIGURE 3



In a gear application, since there are mechanical linkages between the load and motor, the load parameters must be reflected back to the motor shaft. Figure 3 presents the equations.

As an example, if a solid cylinder with a diameter of 4 inches (10.16 cm) and weighing 6 pounds (2718 gm) is connected thru a 3:1 gear, the reflected inertia would be determined by the following:

First, calculating inertia for a solid cylinder:

$$J_{\text{load}} = \frac{1}{2} \frac{WR^2}{g} = \frac{1}{2} \frac{6(2)^2}{386} = .031 \text{ lb-in-s}^2$$

$$\text{Metric} = \frac{1}{2} \frac{2718(5.08)^2}{980} = 35.7 \text{ gm-cm-s}^2$$

reflecting this inertia thru the gear ratio:

$$J_{\text{ref}} = \frac{J_{\text{load}}}{N^2} = \frac{.031}{(3)^2} = .0034 \text{ lb-in-s}^2$$

$$\text{Metric} = \frac{35.7}{(3)^2} = 3.96 \text{ gm-cm-s}^2$$

The total reflected load inertia which the motor would “see” would be .0034 lb-in-s<sup>2</sup> (or metric: 3.96 gm-cm-s<sup>2</sup>).

The inertia of the gears should be included in the determination of total load inertia to be really accurate (this can be obtained from literature or calculated using the formulas for the inertia of a cylinder). Efficiencies of the gearing should also be considered when calculating torques.

## › Tangential Drive

106

Tangential Drive:

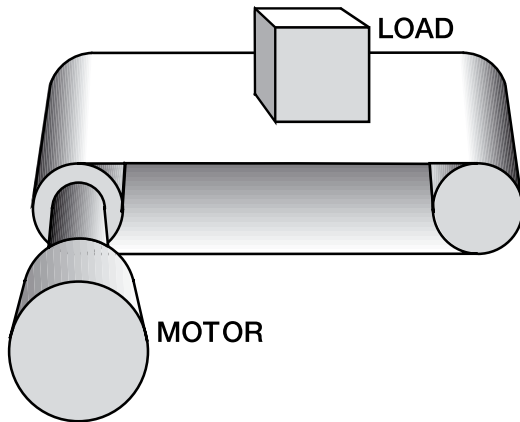

where

- $S_m$  = motor speed (rpm)
- $V_1$  = load speed (in/min) (cm/min)
- $R$  = radius
- $T_1$  = torque reflected to motor
- $F_1$  = load force
- $T_f$  = friction torque
- $F_f$  = friction force
- $J_t$  = total inertia
- $W$  = load weight + belt weight
- $J_p$  = pulley inertia
- $J_m$  = motor inertia
- $g$  = gravitational constant (386 in/s<sup>2</sup>)  
(980 cm/s<sup>2</sup>)

$$\text{speed (motor)} = \frac{1}{2\pi} \times \frac{\text{speed (load)}}{\text{radius}}$$

$$S_m = \frac{1}{2\pi} \times \frac{V_1}{R}$$

load torque = load force x radius

$$T_1 = F_1 R$$

friction torque = frictional force x radius

$$T_f = F_f R$$

total inertia = (weight x radius<sup>2</sup>) ÷ (gravity)  
+ inertia (pulley #1) + inertia (pulley #2)  
+ inertia (motor)

$$J_t = \frac{W R^2}{g} + J_{p1} + J_{p2} + J_m$$

FIGURE 4

For this type of drive, the load parameters have to be reflected back to the motor shaft. A tangential drive can be a timing belt and pulley, chain and sprocket, or rack and pinion. See Figure 4 for formulas.

As an example, a belt and pulley arrangement will be moving a weight of 10 lbs (4530 gm). The pulleys are hollow cylinders of 5 pounds (2265 gm) each with an outer radius of 2.5 inches (6.35 cm) and an inner radius of 2.3 inches (5.8 cm). The total inertia would be determined by:

calculating inertia for a hollow cylinder pulley:

$$J_p = \frac{1}{2} \frac{W}{g} (R_o^2 + R_i^2) = \frac{1}{2} \frac{5}{386} (2.5^2 + 2.3^2) = 0.0747 \text{ lb-in-s}^2$$

$$\text{Metric} = \frac{1}{2} \frac{2265}{980} (6.35^2 + 5.8^2) = 85.39 \text{ gm-cm-s}^2$$

calculating load inertia:

$$J_1 = \frac{W R^2}{g} = \frac{10 (2.5)^2}{386} = 0.1619 \text{ lb-in-s}^2$$

$$\text{Metric} = \frac{4530(6.35)^2}{980} = 186.3 \text{ gm-cm-s}^2$$

the total inertia reflected to the motor shaft would be the sum of the above:

$$J = J_1 + J_{p1} + J_{p2} = 0.1619 + 0.0747 + 0.0747 = 0.3113 \text{ lb-in-s}^2$$

$$\text{Metric} = 357 \text{ gm-cm-s}^2$$

Don't forget to include the inertia of the pulleys, sprockets, or pinion gears in the determination of total inertia.

## › Ballscrew Drive

Leadscrew Drive:

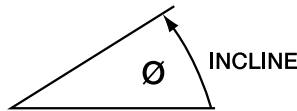
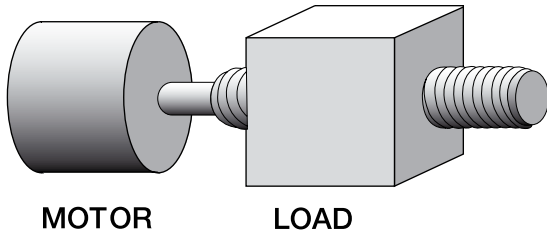

where  $S_m$  = motor speed (rpm)  
 $V_1$  = load speed (in/min) (cm/min)  
 $P$  = pitch (rev/inch) (rev/cm)  
 $T_1$  = torque reflected to motor  
 $F_1$  = load force  
 $F_{p1}$  = preload force  
 $e$  = efficiency  
 $T_f$  = friction torque  
 $F_f$  = friction force  
 $u$  = coefficient of friction  
 $W$  = load weight  
 $J_t$  = total inertia  
 $J_{1s}$  = ballscrew inertia  
 $J_m$  = motor inertia  
 $g$  = gravitational constant (386 in/s<sup>2</sup>)(980 cm/s<sup>2</sup>)

$$\begin{aligned} \text{speed (motor)} &= \text{speed (load)} \times \text{pitch} \\ S_m &= V_1 \times P \end{aligned}$$

$$\text{friction torque} = \frac{1}{2\pi} \frac{\text{load force}}{\text{pitch} \times \text{eff}} + \frac{1}{2\pi} \frac{\text{preload force}}{\text{pitch}} \times 0.2$$

$$T_f = \frac{1}{2\pi} \frac{\mu \times W \cos \theta}{P e} + \frac{1}{2\pi} \frac{F_{p1}}{P} \times 0.2$$

$$\text{load torque reflected to motor} = \frac{1}{2\pi} \frac{\text{push or pull force}}{\text{pitch} \times \text{eff}}$$

$$T_1 = \frac{1}{2\pi} \frac{F_1}{P e}$$

$$\text{total inertia} = \frac{\text{load}}{\text{gravity}} \left( \frac{1}{2\pi \text{pitch}} \right)^2 + \text{leadscrew inertia} + \text{motor inertia}$$

$$J_t = \frac{W \sin \theta}{g e} \left( \frac{1}{2\pi P} \right)^2 + J_{1s} + J_m$$

FIGURE 5

The load parameters have to be reflected back to the motor shaft for this type of drive as well. The inertias which have to be considered include the ballscrew as well as the load. If the ballscrew inertia is not readily available, the formula for a cylinder may be used. Figure 5 presents the formulas for determining reflected inertias.

As an example, a 200 lb (90.6 Kg) load will be positioned via a ballscrew which is 0.5 inch (1.27 cm) in radius and 44 inches (111.7 cm) long. The pitch is 5 rev/inch (1.96 rev/cm). The total load and ballscrew inertia would be:

calculating reflected load inertia:

$$J_1 = \frac{W}{g} \left( \frac{1}{2\pi P} \right)^2 = \frac{200}{386} \left( \frac{1}{2\pi 5} \right)^2 = 0.00052 \text{ lb-in-s}^2$$

$$\text{Metric} = \frac{90600}{980} \left( \frac{1}{2\pi 1.96} \right)^2 = 0.61 \text{ gm-cm-s}^2$$

calculating ballscrew inertia:

$$J_{1s} = \frac{1}{2} \frac{\pi L P R^4}{g} = \frac{1}{2} \frac{\pi (44) (.28) (5)^4}{386} = 0.00313 \text{ lb-in-s}^2$$

$$\text{Metric} = \frac{1}{2} \frac{(111.7)(7.75)(1.27)^4}{980} = 3.6 \text{ gm-cm-s}^2$$

The total inertia which would be connected onto the motor shaft would be the sum of these:

$$J = J_1 + J_{1s} = 0.00052 + 0.00313 = 0.00365 \text{ lb-in-s}^2 \text{ (Metric} = 4.21 \text{ gm-cm-s}^2)$$

For precision positioning applications, the ballscrew is sometimes preloaded to eliminate or reduce backlash. If preloading is used, the preload torque must be included since it can be significant. The ballscrew's efficiency must also be considered when finally determining torques.

## › The Move Profile

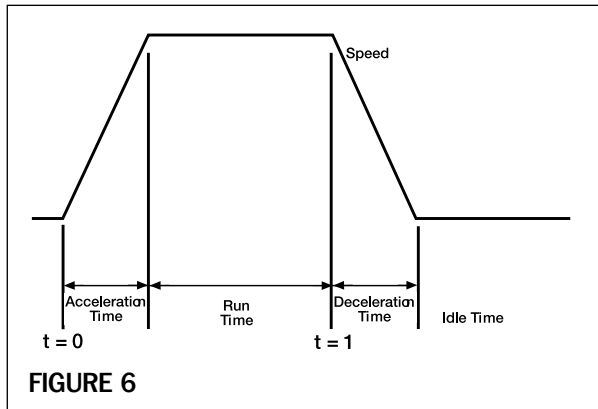

A move profile defines the desired acceleration rate, run time, speed and acceleration rate of the load. For example, suppose with a system at rest (time = 0 in Figure 6), the positioning controller issues a command to the motor to start motion. At t = 0, with full power applied, the motor has not yet started to move. At this instant, there is no feedback signal, but the error signal is large.

As friction and inertia torques are overcome, the motor and load begin to accelerate. As the motor reaches the commanded speed, the error signal is reduced, and in turn the voltage applied onto the motor is reduced. As the system stabilizes at running speed only nominal power (voltage and current) are required (to overcome friction). At time t = 1, the load approaches the desired position and begins to decelerate.

Applications with these move profiles result in most of the input energy dissipated as heat. Such packages are therefore limited by the maximum power dissipation capacity of the motor. In order to guarantee that maximum power handling capability of the motor is not exceeded, each application must be investigated individually. Basic motor dynamic equations must be solved and power calculated for each motor in order to determine whether the application will be handled successfully.

The first step in the process is identifying the acceleration rate. For an example, let's assume that our application has a move profile as identified in Figure 7. The acceleration rate can be determined from the speed and the acceleration time, as follows:

$$\text{accel rate} = \text{speed} \div \text{accel time}$$

$$\text{accel rate (rad/sec}^2\text{)} = \frac{W_m \text{ (rad/sec)}}{t_{\text{acc}} \text{ (sec)}}$$

To convert from RPM to rad/sec divide by 9.55.

For our example the acceleration rate is:

$$\text{accel rate (rad/sec}^2\text{)} = \frac{209 \text{ (rad/sec)}}{.12 \text{ (sec)}} = 1741.6 \text{ rad/sec}^2$$

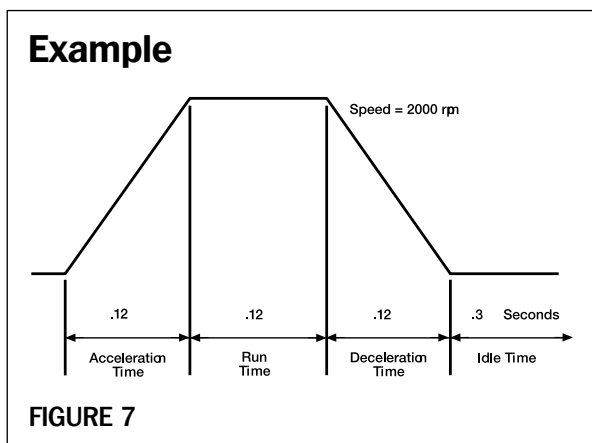

### Example Parameters

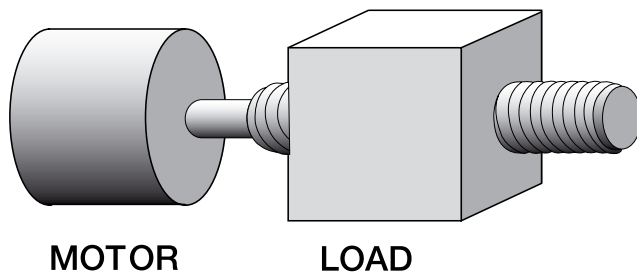

**FIGURE 8**

- Motor Parameters**  
 Inertia = .0037 lb-in-s<sup>2</sup> (4.26 gm-cm-s<sup>2</sup>)  
 Continuous Stall Torque = 14.4 lb-in (1.6 N-m)  
 Torque Constant = 4.8 lb-in/amp (0.54 N-m/amp)  
 Resistance = 4.5 ohms  
 Thermal Resistance = 1.56 °C/watt
- Load Conditions**  
 Load = 200 lbs (90.6 Kg)  
 Ball Screw Inertia = .00313 lb-in-s<sup>2</sup> (0.61 gm-cm-s<sup>2</sup>)  
 Friction Torque = .95 lb-in (1094 gm-cm)

## › Acceleration Torque

110

The torque required to start the load moving, termed acceleration torque ( $T_{acc}$ ), is that torque which is needed to overcome the mechanical friction and inertia. Expressed mathematically, the equation is:

$$T_{acc} = (J_t) (\text{accel rate}) + T_f$$

where  $T_{acc}$  is acceleration torque (lb-in)  
 $J_t$  is the total inertia (load and motor lb-in-s<sup>2</sup>)  
 accel is rotary acceleration of the motor shaft (rad/sec<sup>2</sup>)  
 $T_f$  is the total friction torque of the package (lb-in)

As an example, the application calls for moving a 200 lb (90.6 Kg) load thru a ballscrew (having an inertia of .00313 lb-in-s<sup>2</sup>), (3.6 gm-cm-s<sup>2</sup>) at an acceleration rate of 1741.6 rad/sec<sup>2</sup>. Typical motor parameters which will be used in this analysis are indicated in Figure 8.

$$\begin{aligned}
 T_{acc} &= (J_t) (\text{accel rate}) + T_f \\
 T_{acc} &= (J_l + J_{ls} + J_m) (\text{accel rate}) + T_f \\
 T_{acc} &= (0.00052 + 0.00313 + 0.0037) (1741.6) + 0.95 & \text{Metric} &= (0.61 + 3.6 + 4.26) 1741.6 + 1094 \\
 &= 12.8 + 0.95 & \text{Metric} &= 14751 + 1094 \\
 &= 13.75 \text{ lb-in} & \text{Metric} &= 15845 \text{ gm-cm (=1.55 N-m)}
 \end{aligned}$$

The motor must be capable of providing torque to accelerate the entire mechanics of the load (friction plus inertia), as well as torque to move itself. In this example, the motor must be capable of supplying a total acceleration torque of 13.75 lb-in (15.8 kg-cm).

## › Torque Over the Duty Cycle

The motor must also be capable of providing a certain amount of torque continuously over the duty cycle, or move profile as was defined earlier. In order to determine this, we must look at the rest of the move profile and determine the torques associated with them.

During run time, the torque required is:

$$T_{run} = T_f$$

$$T_{run} = 0.95 \text{ lb-in} \qquad \text{Metric} = (1094 \text{ gm-cm})$$

During the stopping cycle, or deceleration, the torque required is:

$$T_{dec} = -(J) (\text{accel rate}) + T_f$$

$$T_{dec} = -(.00052 + .00313 + .0037) (1741.6) + .95 \qquad \text{Metric} = -(0.61 + 3.6 + 4.26)(1741.6) + 1094$$

$$T_{dec} = -12.8 + .95 \qquad \text{Metric} = -14751 + 1094$$

$$T_{dec} = -11.85 \text{ lb-in} \qquad \text{Metric} = -13657 \text{ gm-cm}$$

Now that these torques are identified, the amount of torque required over the move profile can be calculated. This is termed “determining the RMS torque”. It is calculated by simply inserting the figures from the previous page in to the following equation:

$$T_{RMS}^2 = \frac{(T_{acc}^2 \times t_{acc}) + (T_{run}^2 \times t_{run}) + (T_{dec}^2 \times t_{dec})}{t_{acc} + t_{run} + t_{dec} + t_{idle}}$$

$$T_{RMS}^2 = \frac{(13.75)^2 \times 0.12 + (0.95)^2 \times 0.12 + (11.85)^2 \times 0.12}{0.12 + 0.12 + 0.12 + 0.3} \qquad \text{Metric} = \frac{(15.8)^2 \times 0.12 + (1)^2 \times 0.12 + (13.6)^2 \times 0.12}{0.12 + 0.12 + 0.12 + 0.3}$$

$$T_{RMS}^2 = \frac{22.6 + 0.108 + 16.8}{0.66} = 59.86 \qquad \text{Metric} = \frac{29.9 + 0.12 + 22.1}{0.66} = 78.9 \text{ kg-cm}$$

$$T_{RMS} = 7.73 \text{ lb-in} \qquad \text{Metric} = 8.8 \text{ Kg-cm} (= 0.86 \text{ N-m})$$

Thus, this application requires 7.73 lb-in (0.86 N-m) of torque. The motor for this example has the capability of providing a continuous torque of 14 lb-in (1.6 N-m).

## › Control Section

The next step is to determine requirements for a suitable control or drive (amplifier). The control must be able to supply sufficient acceleration current (for the application's acceleration requirements), as well as continuous current (or "RMS" current for the application's duty cycle requirements).

Acceleration current which must be supplied to the motor is calculated from:

$$\text{current (amps), acceleration} = \frac{\text{acceleration torque (lb-in)}}{\text{motor torque constant (lb-in/amp)}}$$

$$I_{\text{acc}} = \frac{T_{\text{acc}}}{K_{\text{tHOT}}}$$

Where  $K_{\text{tHOT}} = K_{\text{tCOLD}} \times 0.9$  (Typical derate for Neodymium magnets).

$$= \frac{13.75 \text{ (lb-in)}}{4.8 \text{ (lb-in/amp)} \times 0.9} = 3.18 \text{ amps} \quad \text{Metric} = \frac{1.55 \text{ N-m}}{0.54 \text{ N-m/a} \times 0.9} = 3.18 \text{ amp}$$

RMS current over the duty cycle, which the control must be capable of supplying to the motor, is calculated from:

$$\text{current, RMS (amps)} = \frac{\text{RMS torque (lb-in)}}{\text{motor torque constant (lb-in/amp)}}$$

$$I_{\text{RMS}} = \frac{T_{\text{RMS}}}{K_{\text{t}}}$$

$$= \frac{7.73 \text{ (lb-in)}}{4.8 \text{ (lb-in/amp)} \times 0.9} = 1.78 \text{ amps} \quad \text{Metric} = \frac{0.86 \text{ N-m}}{0.54 \text{ N-m/a} \times 0.9} = 1.78 \text{ amp}$$

Thus the servo control which would be selected must have the capability of supplying currents of 3.18 amps for acceleration and 1.78 amps continuously (RMS over the duty cycle).



## Temperature Approximation

The temperature of the internal motor winding, or how hot a motor gets, depends upon the power dissipated inside the motor, and the motor's ability to eliminate itself of that heat. A measure of the motor's capability to eliminate heat is expressed as the thermal resistance.

The first step in determining the motor's winding temperature is to calculate power dissipation (watts dissipated). Using the previous determination of the applications current over the duty cycle, or  $I_{RMS}$  of 1.78 amps, and the motor's resistance:

$$P_{DISS} = I^2 \times R_{HOT}$$

Where  $R_{HOT} = R_{COLD} \times 1.5$

$$P_{DISS} = (1.78)^2 \times 4.5 \times 1.5 = 21.3 \text{ watts.}$$

Then multiply times the motor's thermal resistance (deg C/watt) to obtain the winding temperature rise:

$$\text{Temperature Rise} = P_{DISS} \times R_{th} = 21.3 \times 1.56 = 33.3 \text{ deg C rise}$$

Thus total temperature rise in a 25 deg C ambient would be:

$$\text{Total temperature} = \text{ambient temp} + \text{temp rise} = 25 + 33.3 = 58.3 \text{ deg C}$$

Total temperature in a 40 deg C ambient would be:

$$\text{Total temperature} = 40 + 33.3 = 73.3 \text{ deg C}$$

Since the motor is designed to handle a total temperature of 155 deg C, both would be within the capability of the motor design. This easy calculation works well for speeds below 4000 rpm. At high speeds other dissipation issues such as friction and damping must be considered. If the 155 deg C temperature is exceeded, a larger motor should be investigated for the application.

## › Temperature Rise

114

The basic equation that determines temperature rise is:

$$T = T_{AMB} + (P_{DISS} \times R_{th})(1 - e^{-t/t_{TH}})$$

Where  $t$  = the motors' "on" or operating time, an  $t_{TH}$  = motors' thermal time constant - which is a measure of how long it takes to reach 63.2% of the final or steady state temperature.

The exponential rise of temperature versus time can easily be plotted by using the following points:

$$1/2 t_{TH} = 48\%, t_{TH} = 63.2\%, 3x t_{TH} = 95\%, 5x t_{TH} = 98\%, 7x t_{TH} = 99.99\%$$

This final point ( $7x t_{TH}$ ) is the steady state temperature as calculated in the previous section. These points are shown on the curve in figure 9.

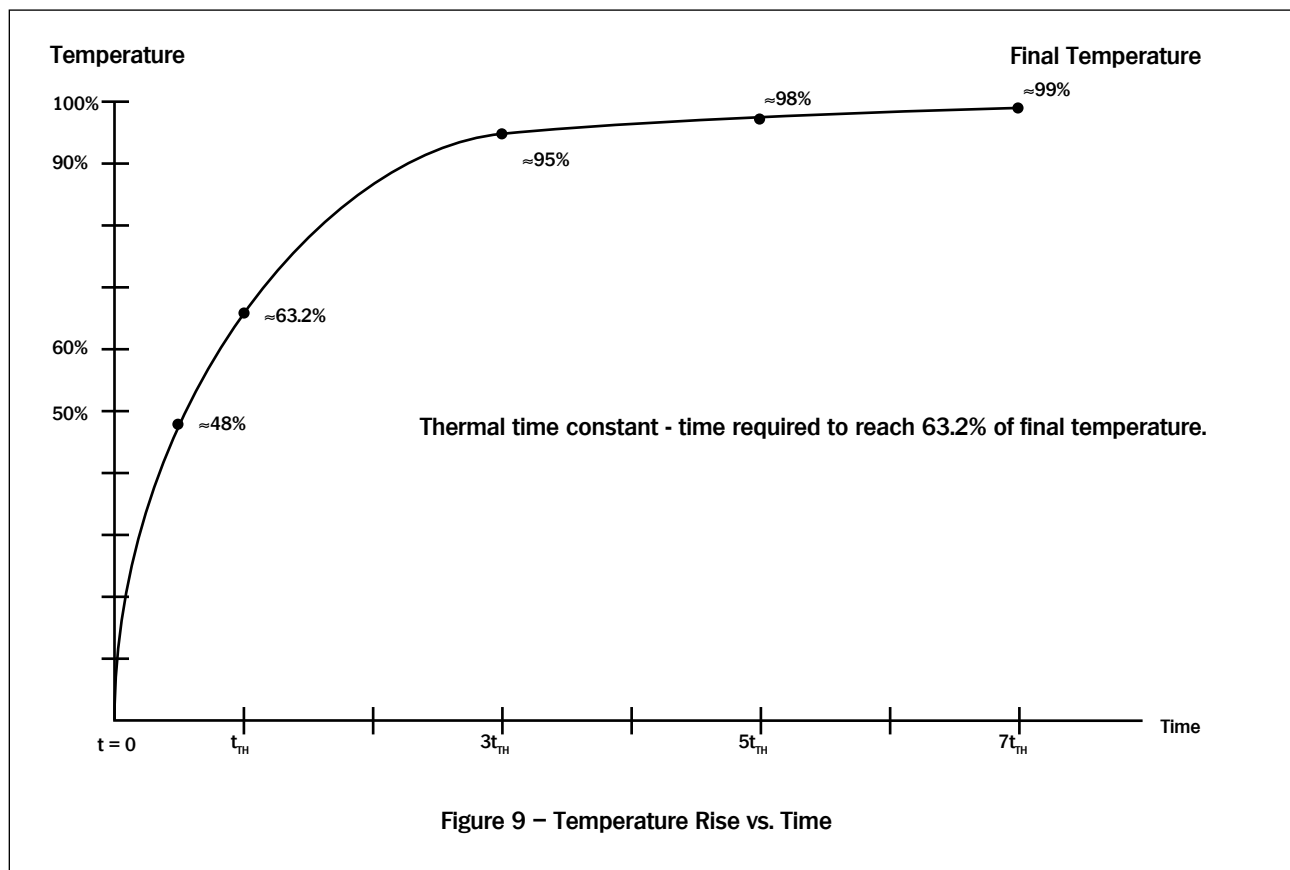

As an example, take the motor that has  $P_{DISS} \times R_{th} = 92^{\circ}\text{C}$  with ambient of  $40^{\circ}\text{C}$ , then temperature rise is shown below, and to determine total temperature, the ambient of  $40^{\circ}\text{C}$  must be added to these figures.

Thus:

Time	$\Delta\text{Temp Rise}$	+ Ambient	= Total Temp.
$1/2 t_{TH}$	$48\% \times 92 = 44.1$	+ 40	= 84.1
$t_{TH}$	$63.2\% \times 92 = 58.1$	+ 40	= 98.1
$3 t_{TH}$	$95\% \times 92 = 87.4$	+ 40	= 127.4
$5 t_{TH}$	$98\% \times 92 = 90.1$	+ 40	= 130.1
$7 t_{TH}$	$99.9\% \times 92 = 92.9$	+ 40	= 132.9

With power applied, the motor winding heats up, attaining 63.2% of final temperature in one thermal time constant, and essentially reaches final temperature in 7 time constants.

## › Servo Motor Requirement Sheet

Company \_\_\_\_\_ Date \_\_\_\_\_

Contact \_\_\_\_\_ E-Mail \_\_\_\_\_

Title \_\_\_\_\_ Phone \_\_\_\_\_

Address \_\_\_\_\_ Fax \_\_\_\_\_

Address \_\_\_\_\_ Industry \_\_\_\_\_

City \_\_\_\_\_ State, Zip \_\_\_\_\_

Describe the application and what you are trying to accomplish:

\_\_\_\_\_

\_\_\_\_\_

## › Velocity Profile

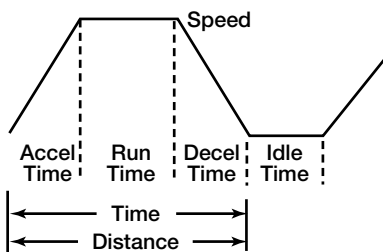

Specify

Speed = \_\_\_\_\_ RPM or in/sec or cm/sec

Accel time = \_\_\_\_\_ sec

Run time = \_\_\_\_\_ sec

Decel time = \_\_\_\_\_ sec

idle time = \_\_\_\_\_ sec

or:

Distance = \_\_\_\_\_ radians; or \_\_\_\_\_ inch or cm

Time (total) = \_\_\_\_\_ sec

Idle time = \_\_\_\_\_ sec

## › Load Conditions

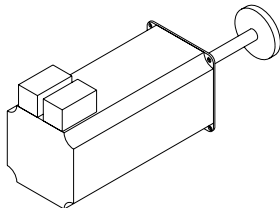

Direct Drive

(Circle Units)

Load inertia = \_\_\_\_\_ lb-in-s<sup>2</sup> (kg-cm<sup>2</sup>)(kg-cm-s<sup>2</sup>)

Load friction = \_\_\_\_\_ lb-in (g-cm)

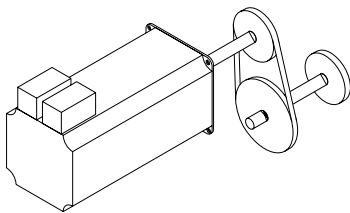

Reduction – belt or gearing

(Circle Units)

Load inertia = \_\_\_\_\_ lb-in-s<sup>2</sup> (kg-cm<sup>2</sup>)(kg-cm-s<sup>2</sup>)

or diameter = \_\_\_\_\_ inch (mm)

and length = \_\_\_\_\_ inch (mm)

Load friction = \_\_\_\_\_ lb-in (g-cm)

Belt/gear ratio = \_\_\_\_\_ :1

Efficiency = \_\_\_\_\_ %

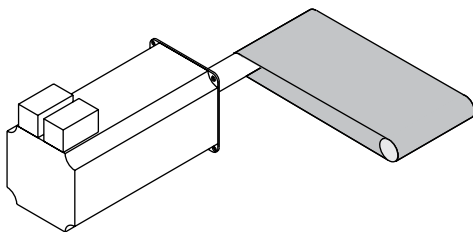

Linear – belt pulley or rack & pinion

(Circle Units)

Load weight = \_\_\_\_\_ lbs (kg)

Belt/rack weight = \_\_\_\_\_ lbs (kg)

Pulley radius = \_\_\_\_\_ inch (mm)

Pulley inertias = \_\_\_\_\_ lb-in-s<sup>2</sup> (kg-cm<sup>2</sup>)(kg-cm-s<sup>2</sup>)

Total friction = \_\_\_\_\_ lb-in (g-cm)

Gear ratio = \_\_\_\_\_ :1

Efficiency = \_\_\_\_\_ %

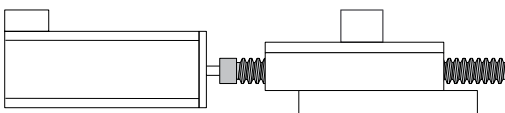

Linear – ball screw

(Circle Units)

Load weight = \_\_\_\_\_ lbs (kg)

load friction = \_\_\_\_\_ lb-in (g-cm)

Screw pitch = \_\_\_\_\_ rev/inch (mm/rev)

Screw inertia = \_\_\_\_\_ lb-in-s<sup>2</sup> (kg-cm<sup>2</sup>)(kg-cm-s<sup>2</sup>)

or Diameter = \_\_\_\_\_ inch (mm)

and Length = \_\_\_\_\_ inch (mm)

Efficiency = \_\_\_\_\_ %

# Quick Selection of Planetary Gearheads

Baldor has made selection relatively simple by listing input torque ratings for each size and ratio. The data sheets are set up such that if the input torque ratings are not exceeded, the output torque capabilities of a gearhead will not be exceeded.

Focus on motor-drive selection, including the desired gear ratio: Then proceed to optimize gearhead selection based on desired torque margin, and backlash. Keep in mind that during the process of selecting the motor-drive combination, one has also inherently determined (a) motor continuous torque, (b) motor accelerating torque, (c) motor speeds – peak and continuous. These are the values that will be the input to the gearhead. It follows that the gearhead must be capable of handling those input values for an indicated period of time. Next, observe the rule of “do not exceed the input torque rating of a gearhead”.

Gearhead data (characteristics or specs) sheets list two torque ratings – maximum rated torque and maximum accel (acceleration) torque. Accel torque can be viewed as “Allowable Peak” torque.

It frequently happens in servo applications that a required motor has the ability to provide much more torque than is needed to drive the load. This typically happens with large (2 or 3 stage) gear ratios or inertia matching applications. When this situation occurs, it is prudent to employ the current limiting function of the control. By limiting the current, the amount of torque that can be inputted to a gearhead is limited – therefore, in the event of a machine jam, the motor is not able to supply torque that could cause the gearhead to be damaged. Note also, that the use of current limiting can often enable the use of a smaller gearhead than might otherwise be required to handle motor peak torque.

A word about inertia matching – if one is accelerating an inertial load, the reflected inertia of the gearhead is usually very small in comparison to the load inertia and can be practically ignored.

### Using the “Quick Selection” Charts

Standard gearheads have a maximum motor shaft diameter that can be accommodated. The quick selection chart shows only combinations that are compatible for standard gearheads.

The quick selection charts are intended to get one in the “ballpark” as to selection. When considering the indicated “quick selection”, it is prudent to consider the duty cycle to evaluate the “safety factor” inherent in the indicated selection.

In the quick selection charts, the gearheads listed, assume maximum motor rated torque is utilized. The amount of motor peak torque that can be accommodated depends upon the gear ratio. As the gear ratio becomes higher, the gear is less likely to handle the motors peak torque capability. One must then consider a larger gearhead than shown in the quick selection chart if some of the motor peak torque has to be utilized.

## Duty Cycle Considerations

Knowing the intended duty cycle is a critical element of gearhead sizing. There are an infinite number of duty cycles, but for simplicity, usually rating information for conditions called S1 and S5 are provided.

S1 is “continuous duty” – the motor is started and runs for long periods, such as all day, at essentially constant torque and speed.

S5 is intermittent duty – This describes a cycle where the motor is started, accelerates a load to a high speed, then may run at a lower speed and torque for a brief period of time. Then there is braking and a definite pause (stop) in the cycle. After this rest period, the cycle is repeated. It is common to describe the total “on-time” of the cycle in fractions of an hour, and the time span of a single cycle. For example, S-5 ratings should be considered to be for a maximum of 60% on-time, and 20 minutes maximum per cycle. Employ a larger gearhead if the duty cycle is more severe.

Gearhead input speed is also a part of a duty cycle. The gearhead specs list two maximum input speeds – a max speed for S1 duty and a max speed for S5 (Accel) duty. The largest speed combination listed is 4000/6000 rpm. These values are lower for larger gearheads. Gearheads are not available for higher speeds than listed. Higher speeds lead to over heating and dynamic balancing issues.

Always use electronic “ramping” to accelerate and decelerate loads. A gearhead can be severely damaged if it hits a “dead stop”. “Plug reversing” an inertial load can also destroy a gearhead – under such conditions, the gearhead can be “wrenched” and behaves like a spring that can break. In other words, with a load attached, gearhead stops need to be controlled.

A limited number of “emergency stops” can be accommodated. Look for a footnote on the respective data sheet. Generally, they state that up to 1,000 times in the life of a gearhead, an emergency stop torque of 2.5 times rated torque can be withstood.

## Gearhead Life Extending Considerations

The design life of each gearhead is indicated on its data sheet. For example, GBSM050-MRP050 gearheads are rated for 15,000 operating hours. This means that at rated torque and speed, if the temperature is okay, the gearhead is designed to provide the “design life”.

Note that a 40-hour week is about 2,000 operating hours per year. A 24-7 operating schedule is about 8,700 hours per year.

After a gearhead has operated for its rated life, to reduce the probability of wear-out, it is prudent to refurbish the gearhead, replacing the seals (if present), bearings, and lubricant.

To achieve longer life in an application, consider the following:

- Use a larger gearhead than normal sizing procedures call for. The gear teeth have to carry less force, so they lubricate better and generate less heat. Note that reflected inertia increases with gearhead size.
- Operate at lowest possible input speeds. The gear teeth and bearings see fewer revolutions and last longer.
- Keep the gearhead cool. Max case temperature should be 90 degrees C (194 F). Higher temperatures literally cook the lubricants in the gears and the bearings, changing their chemistry, which shortens their lubricating powers exponentially. Excessive temperatures also thin the lubricants, lowering their ability to support loads. Moreover, excessive temperatures shorten shaft seal life (on oil lubricated gearheads). Note that hot running motors can “feed” heat into a gearhead.

## Radial and Axial Loads – on the gearhead output shaft

For each size gearhead, maximum values for these parameters are included on the data sheet. These are “simplified” values. For example, the radial load rating is given as being in the middle of the output shaft at 300 rpm. The radial load can be higher if it is closer to the gearhead, or if the gearhead is rotating slower. Moreover, the data sheet infers radial and axial loads are independent: They are actually interrelated. Consult Baldor if near maximum radial and axial loads are contemplated.

# Conversion Tables

120

## Rotary Inertia (To convert from A to B, multiply by value in table)

A \ B	gm-cm <sup>2</sup>	oz-in <sup>2</sup>	gm-cm-s <sup>2</sup>	kg-cm <sup>2</sup>	lb-in <sup>2</sup>	oz-in-s <sup>2</sup>	lb-ft <sup>2</sup>	kg-cm-s <sup>2</sup>	lb-in-s <sup>2</sup>	lb-ft-s <sup>2</sup> or slug-ft <sup>2</sup>
gm-cm <sup>2</sup>	1	5.46 x 10 <sup>-3</sup>	1.01 x 10 <sup>-3</sup>	10 <sup>-3</sup>	3.417 x 10 <sup>-4</sup>	1.41 x 10 <sup>-5</sup>	2.37 x 10 <sup>-6</sup>	1.01 x 10 <sup>-6</sup>	8.85 x 10 <sup>-7</sup>	7.37 x 10 <sup>-8</sup>
oz-in <sup>2</sup>	182.9	1	0.186	0.182	0.0625	2.59 x 10 <sup>-3</sup>	4.34 x 10 <sup>-4</sup>	1.86 x 10 <sup>-4</sup>	1.61 x 10 <sup>-4</sup>	1.34 x 10 <sup>-5</sup>
gm-cm-s <sup>2</sup>	980.6	5.36	1	0.9806	0.335	1.38 x 10 <sup>-2</sup>	2.32 x 10 <sup>-3</sup>	10 <sup>-3</sup>	8.67 x 10 <sup>-4</sup>	7.23 x 10 <sup>-5</sup>
kg-cm <sup>2</sup>	1000	5.46	1.019	1	0.3417	1.41 x 10 <sup>-2</sup>	2.37 x 10 <sup>-3</sup>	1.019 x 10 <sup>-3</sup>	8.85 x 10 <sup>-4</sup>	7.37 x 10 <sup>-5</sup>
lb-in <sup>2</sup>	2.92 x 10 <sup>3</sup>	16	2.984	2.926	1	4.14 x 10 <sup>-2</sup>	6.94 x 10 <sup>-3</sup>	2.98 x 10 <sup>-3</sup>	2.59 x 10 <sup>-3</sup>	2.15 x 10 <sup>-4</sup>
oz-in-s <sup>2</sup>	7.06 x 10 <sup>4</sup>	386.08	72	70.615	24.13	1	0.1675	7.20 x 10 <sup>-2</sup>	6.25 x 10 <sup>-2</sup>	5.20 x 10 <sup>-3</sup>
lb-ft <sup>2</sup>	4.21 x 10 <sup>5</sup>	2304	429.71	421.40	144	5.967	1	0.4297	0.3729	3.10 x 10 <sup>-2</sup>
kg-cm-s <sup>2</sup>	9.8 x 10 <sup>5</sup>	5.36 x 10 <sup>3</sup>	1000	980.66	335.1	13.887	2.327	1	0.8679	7.23 x 10 <sup>-2</sup>
lb-in-s <sup>2</sup>	1.129 x 10 <sup>6</sup>	6.177 x 10 <sup>3</sup>	1.152 x 10 <sup>3</sup>	1.129 x 10 <sup>3</sup>	386.08	16	2.681	1.152	1	8.33 x 10 <sup>-2</sup>
lb-ft-s <sup>2</sup> or slug-ft <sup>2</sup>	1.355 x 10 <sup>7</sup>	7.41 x 10 <sup>4</sup>	1.38 x 10 <sup>4</sup>	1.35 x 10 <sup>4</sup>	4.63 x 10 <sup>3</sup>	192	32.17	13.825	12	1

## Torque (To convert from A to B, multiply by value in table)

A \ B	dyne-cm	gm-cm	oz-in	kg-cm	lb-in	Newton-m	lb-ft	kg-cm
dyne-cm	1	1.019 x 10 <sup>-3</sup>	1.416 x 10 <sup>-5</sup>	1.0197 x 10 <sup>-6</sup>	8.850 x 10 <sup>-7</sup>	10 <sup>-7</sup>	7.375 x 10 <sup>-8</sup>	1.019 x 10 <sup>-8</sup>
gm-cm	980.65	1	1.388 x 10 <sup>-2</sup>	10 <sup>-3</sup>	8.679 x 10 <sup>-4</sup>	9.806 x 10 <sup>-5</sup>	7.233 x 10 <sup>-5</sup>	10 <sup>-5</sup>
oz-in	7.061 x 10 <sup>4</sup>	72.007	1	7.200 x 10 <sup>-2</sup>	6.25 x 10 <sup>-2</sup>	7.061 x 10 <sup>-3</sup>	5.208 x 10 <sup>-3</sup>	7.200 x 10 <sup>-4</sup>
kg-cm	9.806 x 10 <sup>5</sup>	1000	13.877	1	0.8679	9.806 x 10 <sup>-2</sup>	7.233 x 10 <sup>-2</sup>	10 <sup>-2</sup>
lb-in	1.129 x 10 <sup>6</sup>	1.152 x 10 <sup>3</sup>	16	1.152	1	0.112	8.333 x 10 <sup>-2</sup>	1.152 x 10 <sup>-2</sup>
Newton-m	10 <sup>7</sup>	1.019 x 10 <sup>4</sup>	141.612	10.197	8.850	1	0.737	0.101
lb-ft	1.355 x 10 <sup>7</sup>	1.382 x 10 <sup>4</sup>	192	13.825	12	1.355	1	0.138
kg-m	9.806 x 10 <sup>7</sup>	10 <sup>5</sup>	1.388 x 10 <sup>3</sup>	100	86.796	9.806	7.233	1



### Material Densities

	Oz/in <sup>2</sup>	lb/in <sup>3</sup>	gm/cm <sup>3</sup>
Aluminum	1.57	0.098	2.72
Brass	4.96	0.31	8.6
Bronze	4.72	0.295	8.17
Copper	5.15	0.322	8.91
Plastic	0.64	0.04	1.11
Steel	4.48	0.28	7.75

### Mechanism Efficiencies

Acme Screw (Bronze Nut)	0.4
Acme Screw (Plastic Nut)	0.5
Ball Screw	0.9
Helical Gear	0.7
Spur Gear	0.6
Timing Belt/Pulley	0.9

### Friction Coefficients

(Sliding)	m
Steel on Steel	0.58
Steel on Steel (Greased)	0.15
Aluminum on Steel	0.45
Copper on Steel	0.36
Brass on Steel	0.40
Plastic on Steel	0.20
Linear Bearings	0.001

### Temperature

$$^{\circ}\text{F} = (1.8 \times ^{\circ}\text{C}) + 32$$

$$^{\circ}\text{C} = .555 (^{\circ}\text{F} - 32)$$

### Gravity

(Acceleration Constant)

$$g = 386 \text{ in/s}^2 = 32.2 \text{ ft/s}^2 = 9.8 \text{ m/s}^2$$

# Conversion Tables

122

**Length** (To convert from A to B, multiply by value in table)

A \ B	Inch	Feet	Micro Inch	Micron	Millimeter	Centimeter	Meter
Inch	1	$8.33 \times 10^{-2}$	$1.0 \times 10^6$	$2.51 \times 10^4$	25.4	2.54	$2.54 \times 10^{-2}$
Feet	12	1	$1.2 \times 10^7$	$3.05 \times 10^5$	305	30.5	0.305
Micro-Inch	$1.0 \times 10^{-6}$	$1.2 \times 10^4$	1	$2.54 \times 10^{-2}$	$2.54 \times 10^{-5}$	$2.54 \times 10^{-6}$	$2.54 \times 10^{-8}$
Micron	$3.937 \times 10^{-5}$	$3.28 \times 10^{-6}$	39.37	1	0.001	$1.0 \times 10^{-4}$	$1.0 \times 10^{-6}$
Millimeter	$3.937 \times 10^{-2}$	$3.28 \times 10^{-3}$	$3.937 \times 10^4$	1000	1	0.1	0.001
Centimeter	0.3937	$3.28 \times 10^{-2}$	$3.937 \times 10^5$	$1 \times 10^4$	10	1	0.01
Meter	39.37	3.28	$3.937 \times 10^7$	$1 \times 10^6$	1000	100	1

**Power** (To convert from A to B, multiply by value in table)

A \ B	Watts	Kilowatts	ft-lb/sec	in-lb/sec	Hp (Imperial)	Hp (SI)
Watts	1	$1 \times 10^{-3}$	0.74	8.85	$1.34 \times 10^{-3}$	$1.33 \times 10^{-3}$
Kilowatts	1000	1	738	8850	1.34	1.33
ft-lb/sec	1.35	$1.36 \times 10^{-3}$	1	12	$1.82 \times 10^{-3}$	$1.81 \times 10^{-3}$
in-lb/sec	0.113	$1.13 \times 10^{-4}$	$8.3 \times 10^{-2}$	1	$1.52 \times 10^{-4}$	$1.53 \times 10^{-4}$
Hp (Imperial)	746	0.746	550	6600	1	0.995
Hp (SI)	750	0.750	553	6636	1.005	1

**Mass** (To convert from A to B, multiply by value in table)

A \ B	oz-m	lb-m	slug	gm	kg
oz-m	1	$6.25 \times 10^{-2}$	$1.94 \times 10^{-3}$	28.35	$2.835 \times 10^{-2}$
lb-m	16	1	$3.11 \times 10^{-2}$	453.6	0.453
slug	514.72	32.2	1	14590	14.59
gm	$3.53 \times 10^{-2}$	$2.205 \times 10^{-3}$	$6.85 \times 10^{-5}$	1	0.001
kg	35.274	2.205	$6.85 \times 10^{-2}$	1000	1

**Force** (To convert from A to B, multiply by value in table)

A \ B	oz-f	lb-f	Newtons	dyne	gm-f	kg-f
oz-f	1	$6.25 \times 10^{-2}$	0.278	$2.78 \times 10^4$	28.35	$2.835 \times 10^{-2}$
lb-f	16	1	4.448	$4.448 \times 10^5$	453.6	0.4535
Newtons	3.596	0.225	1	$1 \times 10^5$	101.9	0.1019
dyne	$3.59 \times 10^{-5}$	$2.248 \times 10^{-6}$	$1.0 \times 10^{-5}$	1	$1.02 \times 10^{-3}$	$1.02 \times 10^{-6}$
gm-f	$3.53 \times 10^{-2}$	$2.205 \times 10^{-3}$	$9.81 \times 10^{-3}$	981	1	0.001
kg-f	35.3	2.205	9.81	$9.81 \times 10^5$	1000	1

**Linear Velocity** (To convert from A to B, multiply by value in table)

A \ B	in/sec	feet/sec	mm/sec	cm/sec	meter/sec	inch/min	feet/min	meter/min	km/hour	miles/hour
in/sec	1	0.083	25.4	2.54	$2.54 \times 10^{-2}$	60	5	1.524	0.091	$5.7 \times 10^{-2}$
feet/sec	12	1	304.8	30.48	0.3048	720	60	18.29	1.09	0.682
mm/sec	$3.937 \times 10^{-2}$	$3.3 \times 10^{-3}$	1	0.1	0.001	2.36	0.197	0.059	$3.6 \times 10^{-3}$	$2.24 \times 10^{-3}$
cm/sec	0.3937	$3.28 \times 10^{-2}$	10	1	0.01	23.62	1.97	0.59	$3.6 \times 10^{-2}$	$2.24 \times 10^{-2}$
meter/sec	39.37	3.281	1000	100	1	2362.2	197	60	3.6	2.24
inch/min	0.0167	$1.39 \times 10^{-3}$	0.42	0.042	$4.2 \times 10^{-4}$	1	$8.33 \times 10^{-2}$	$2.54 \times 10^{-2}$	$1.52 \times 10^{-3}$	$9.5 \times 10^{-4}$
feet/min	0.2	0.0167	5.08	0.508	$5.08 \times 10^{-3}$	12	1	0.3048	$1.8 \times 10^{-2}$	$1.14 \times 10^{-2}$
meter/min	0.656	$5.46 \times 10^{-2}$	16.667	1.67	$1.67 \times 10^{-2}$	39.4	3.28	1	$5.9 \times 10^{-2}$	0.37
km/hour	10.936	0.911	277.8	27.78	0.2778	656	54.67	16.67	1	0.62
miles/hour	17.59	1.47	447	44.7	0.447	1056	88	26.8	1.609	1

# Servo Drive Solutions



Whether you are looking for a simple servo drive or a fully programmable drive, Baldor has the answer. Baldor servo drives have been at the heart of automation for over 20 years and have been used in thousands of applications across the world. Our latest drives build on the reputation of quality and ease of use and are ideally matched to Baldor's range of NextMove motion controllers, rotary servo motors and linear servo motors. Commissioning and setup use the same acclaimed Mint® WorkBench Windows based tool as the NextMove controllers, reducing the learning curve and improving productivity.



## VS1SD Servo Drive

**Refer to catalog BR1202-D for full information.**

Baldor's new series incorporates an easy to use keypad for setup, auto-tuning and operation. The keypad's graphical alphanumeric display provides full parameter names to simplify setup and operation, 14 keys provide tactile feel. Includes auto-tuning. Optional field installable expansion boards extend capability to suit application needs. Models include internal power supply and are available in three phase ratings from 180-264 VAC (3 to 130A) and three phase 340-528 VAC (3 to 124A). Vector, encoderless vector and inverter drives are also available.



**FlexDrive-II, Flex+Drive®-II and MintDrive®-II**

**Refer to catalog BR1202-D for full information.**

Baldor's Series-II servo drives offer high performance control of both rotary and linear brushless servo motors. This fully featured drive family offers different feedback options (resolver, incremental and absolute multi-turn encoders) and fieldbusses (CANopen, DeviceNet and Profibus-DP). Models are available with single phase 115/230VAC (2.5 to 7.5A) or universal three phase 180-460 VAC (2.5 to 27.5A) inputs.

The FlexDrive-II is a servo drive for connection to a motion controller or PLC accepting the industry standard  $\pm 10V$  analog interface. The Flex+Drive-II is a versatile indexing drive. In addition to setting position or speeds within a simple Windows® based front end, Flex+Drive-II is programmable in a single tasking version of Baldor's motion language, Mint®. The MintDrive-II provides the ultimate solution for single axis applications. Support the acclaimed multitasking version of Mint, MintDrive-II is ideally suited for following type applications requiring CAM profiles, flying shears or positional offsets.



**Motion Controllers - NextMove series**

**Refer to catalog BR1202-C for full information.**

Baldor provides high performance controllers for coordinated motion. These controllers represent industry's most dependable, and fastest product available. The NextMove family of products will speed up your manufacturing time, minimize set-up and increase your manufacturing process.

# Motor Solutions

For over 20 years, Baldor has been manufacturing and supplying high reliability servo motor solutions to worldwide applications. Baldor's servo motors are designed for industrial applications, superior durability and proven reliability. Our range of rotary motors are available as a high performance, low inertia family, or as a higher inertia family for applications needing higher inertial matching. Baldor's new stainless steel motors lead the way in solutions for harsh and washdown environments.

With the widest range of linear motors and stages on the market today, Baldor's linear motors lead the way and are ideally suited to applications requiring higher speeds or improved accuracy.



## Linear Motors and Stages

**Refer to catalog BR1202-G for full information.**

Used in thousands of applications worldwide, Baldor provides industry with the widest range of linear motors and linear stages. Linear motors provide unique speed and positioning performance advantages. The direct-coupled motion eliminates mechanical transmission devices and offer substantial improvements over applications using ball screws, timing belts, etc. The rugged mechanical design provides accurate motion and precision positioning for millions of cycles. Products include:

- › Cog free linear motors for high precision, high speed applications
- › Single and dual axis stepper motors
- › Cog free linear motor stages, including XYZ stages
- › HyCore™ linear motor for low cost linear motor applications
- › Linear induction motors



### DSMS - Integrated Stepper Motor and Drive

Baldor's DSMS integrated stepper motor and microstepping drive provides a cost effective solution for stepper motor applications. The unique design integrates a high performance micro-stepping drive onto a stepper motor, providing a compact and reliable solution. Wiring is reduced to just pulse and direction plus power. The range is available in NEMA frames sizes 17, 23 and 34 with torque outputs from 22 to 748 N-cm (32 to 1061 oz-in)



### DC Servo Motors

**Refer to catalog BR1202-F for full information.**

The Baldor family of DC servo motors (PMDC) provide continuous torques from 0.21Nm to 6.55Nm (1.8 lb.-in to 58 lb.-in.) These high performance motors are designed to meet the demanding requirements of industrial motion control. A wide variety of windings and feedback devices are available for your application needs.

## Baldor's Motion Solutions Catalogs

- BR1202-A** Motion Control Solutions
- BR1202-B** Mint® Software and Applications
- BR1202-C** NextMove Multi-Axis Motion Controllers
- BR1202-D** AC Servo Drives
- BR1202-E** AC Servo Motors
- BR1202-F** DC Servo Motors and Drives
- BR1202-G** Linear Motors and Stages
- BR1202-H** Motion Product Accessories
- BR1202-I** Real-Time Ethernet Motion Solutions

### World Headquarters (U.S.A.)

#### Baldor Electric Company

Tel: +1 479 646-4711  
Fax: +1 479 648-5792  
E-mail: sales.us@baldor.com

#### Australia

Tel: +61 2 9674 5455  
Fax: +61 2 9674 2495  
E-mail: sales.au@baldor.com

#### China

Phone: +86-21-64473060  
Fax: +86-21-64078620  
E-mail: sales.cn@baldor.com

#### Germany

Tel: +49 89 905 08-0  
Fax: +49 89 905 08-490  
E-mail: sales.de@baldor.com

#### India

Tel: +91 20 25 45 95 31/32  
Fax: +91 20 25 45 95 30  
E-mail: sales.in@baldor.com

#### Italy

Tel: +41 91 640 9950  
Fax: +41 91 630 2633  
E-mail: sales.it@baldor.com

#### Japan

Tel: +81 45-412-4506  
Fax: +81 45-412-4507  
E-mail: sales.jp@baldor.com

#### Korea

Tel: +(82-32) 508 3252  
Fax: +(82-32) 508 3253  
E-mail: sales.kr@baldor.com

#### Mexico

Tel: +52 477 761 2030  
Fax: +52 477 761 2010  
E-mail: sales.mx@baldor.com

#### Singapore

Tel: +65 744 2572  
Fax: +65 747 1708  
E-mail: sales.sg@baldor.com

#### Switzerland

Tel: +41 52 647 4700  
Fax: +41 52 659 2394  
E-mail: sales.ch@baldor.com

#### United Kingdom

Tel: +44 1454 850000  
Fax: +44 1454 859001  
E-mail: sales.uk@baldor.com

For additional office locations visit

[www.baldor.com](http://www.baldor.com)

Local Distributor: